

Project:	Type:
	Comments:

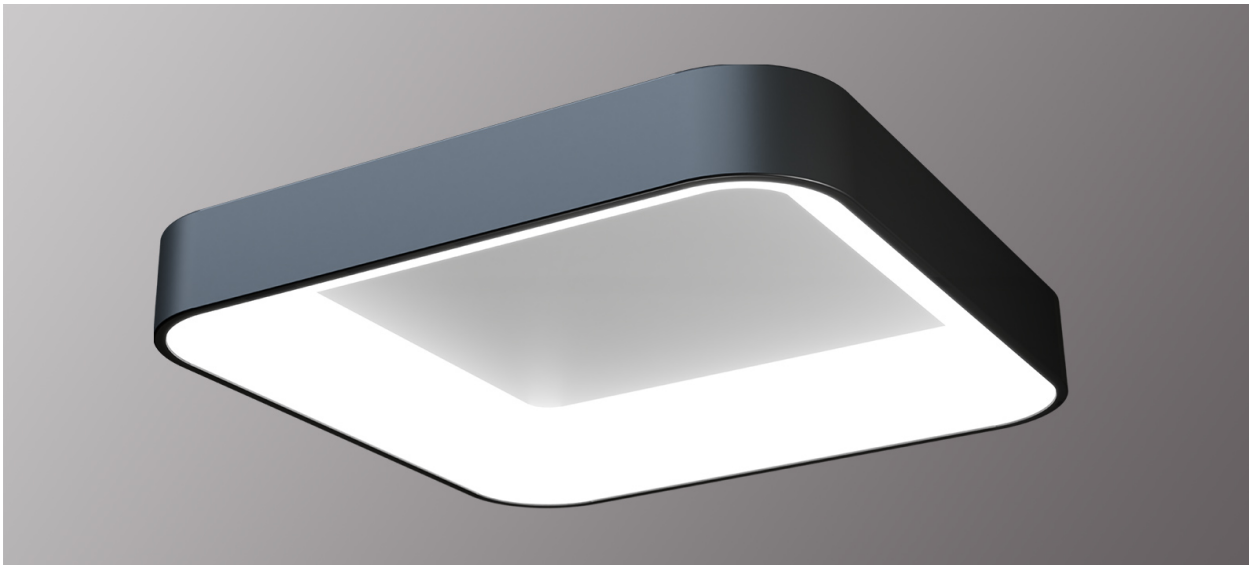

Highlights

The **TechoLED Acoustic Series** provides an elegant and effective solution for reducing noise and reverberation in large, open spaces. Our luminaires are crafted from high-quality, rigid, acoustically rated materials, ensuring an easy-to-specify and install integrated solution. With a wide range of sizes, form factors, and finishes - from standard colors to faux wood - we offer an acoustic solution to complement every modern interior.

LED: Samsung LED chips, 2700-5000K, tunable white and RGB/W, 90CRI

Optical: Direct illumination, 152° Beam Angle

Construction: High grade aluminum extrusion, acoustic rated material, curved PC diffuser, acoustic material available in multiple colors/finishes

Installation

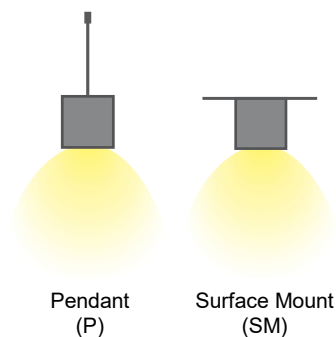

Project:	Type:
	Comments:

Configuration Example

Model #	Distribution	Size	Lumen Output	Color Temp.	Voltage	Color
TECHOLED-ASR-D-14-LO-30-U-W	Direct	14.2"x14.2"	Low	3000K	110-277V	White

Ordering Guide:

Select one option from each group below. For a custom preference please contact sales@techoled.com

1-FIXTURE ID		2-DISTRIBUTION		3-SIZE		4-LUMEN OUTPUT	
ASR	Racetrack	D	Direct	14	14.2"x14.2"	LO	Low
				17	17.7"x17.7"	ME	Medium
				23	23.6"x23.6"	HI	High
				31	31.5"x31.5"		

5-COLOR TEMP.		6-VOLTAGE		6-VOLTAGE		8-ACOUSTIC FELT FINISH	
27	2700K	U	120-277V	U	120-277V	X	None
30	3000K	HV	347V	HV	347V	Xxx	See Color Palette
35	3500K						
40	4000K						
50	5000K						
DT	Lutron T-series						
RGB	RGB						
RGBW	RGBW						
D	Tunable White						

9-MOUNTING		10-DRIVER OPTIONS		11-OPTIONS		12-OPTIONS (CONT.)	
SM	Surface Mount	DM	0-10V Dimming	RF-D	Remote Tunable (RF only)	EM	EM Battery (remote)
P	Pendant	2C	2 Channel	RF-R	Remote RGB/W (RF only)	X	None
		DM1%	1% Dimming	M	Motion Sensor (remote)		
		LT1	LDE1 Lutron 1%	BM	BubblyNet BT Mesh		
		DA	Dali	CS	Casambi		
		DMX	DMX	AWNDR	Lutron Athena Node		
		TR	Triac Dimming	AWNRS	Lutron Athena Node sensor		
		RF	RF Wireless	NL-ES7	nLight - Wired		
		X	None	NL-AIR	nLight - AIR		
				NL-M	nLight - Module only		
				X	None		

Project:	Type:
	Comments:

Lumen Output Details

Model #	Size	Output	Color Temp.	Wattage	Lumen Output
TECHOLED-ASR-D-14-LO-30	14.2"x14.2"	Low	3000K	18W	1260Lm
TECHOLED-ASR-D-14-ME-30	14.2"x14.2"	Medium	3000K	18W	1260Lm
TECHOLED-ASR-D-14-HI-30	14.2"x14.2"	High	3000K	25W	1750Lm
TECHOLED-ASR-D-17-LO-30	17.7"x17.7"	Low	3000K	20W	1400Lm
TECHOLED-ASR-D-17-ME-30	17.7"x17.7"	Medium	3000K	25W	1750Lm
TECHOLED-ASR-D-17-HI-30	17.7"x17.7"	High	3000K	30W	2100Lm
TECHOLED-ASR-D-23-LO-30	23.6"x23.6"	Low	3000K	25W	1750Lm
TECHOLED-ASR-D-23-ME-30	23.6"x23.6"	Medium	3000K	36W	2520Lm
TECHOLED-ASR-D-23-HI-30	23.6"x23.6"	High	3000K	50W	3500Lm
TECHOLED-ASR-D-31-LO-30	31.5"x31.5"	Low	3000K	40W	2800Lm
TECHOLED-ASR-D-31-ME-30	31.5"x31.5"	Medium	3000K	50W	3500Lm
TECHOLED-ASR-D-31-HI-30	31.5"x31.5"	High	3000K	60W	4200Lm

Performance above applies to 90 CRI, 3000K. Calculate 96% for 2700K, 104% for 3500K and 109% for 4000K

Performance

Output	Lumens / W
Low	70
Medium	70
High	70

Project:	Type:
	Comments:

Driver Option Details

Code	Description
LT1	LDE1 -Lutron Hi-lume 1% EcoSystem, Soft-on, Fade-to Black Dimming
DA	DALI
DMX	DMX - Decoder provided by TechoLED, controller by others

Controls Details

Code	Description
RF-D	RF Wireless remote controller for tunable white. Default for tunable white.
RF-R	RF Wireless remote controller for RGB & RGBW. Default for RGB & RGBW.
M	Motion Sensor - remote, for integral sensor consult factory
BM	Bluetooth Mesh Smart Wireless Control by BubblyNet
CS	Bluetooth Mesh Smart Wireless Control by Casambi
AWN R	Lutron Athena wireless node
AWN S	Lutron Athena wireless node with sensor
NL-ES7	Acuity nLight – Wired nES7 sensor
NL-AIR	Acuity nLight – AIR wireless rES7 sensor
NL-M	Acuity nLight - ready, sensor by others

Project:	Type:
	Comments:

Dimension and Mounting

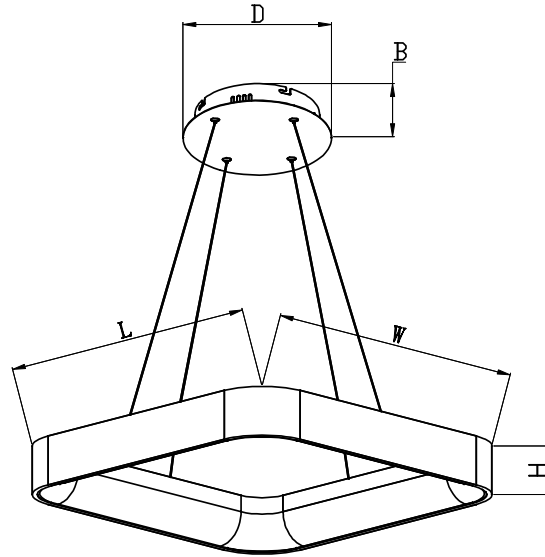

FIXTURE ID	L	W	H	D	B
ASR-D-14-15	14.2"	14.2"	3.5"	10"	2"
ASH-D-23-40	17.7"	17.7"	3.5"	10"	2"
ASH-D-35-90	23.6"	23.6"	3.5"	10"	2"
ASH-D-47-180	31.5"	31.5"	3.5"	10"	2"

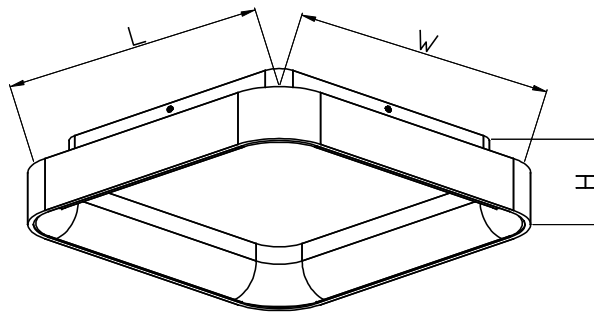

FIXTURE ID	L	W	H
ASR-D-14-15	14.2"	14.2"	4.6"
ASR-D-23-40	17.7"	17.7"	4.6"
ASR-D-35-90	23.6"	23.6"	4.6"
ASR-D-47-180	31.5"	31.5"	4.6"

Project:	Type:
	Comments:

Photometrics

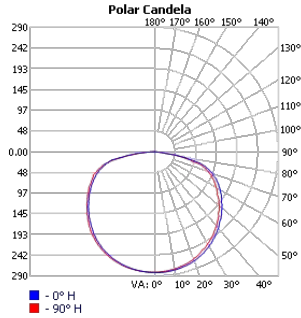

TECHOLED-ASR-D-14-LO-30

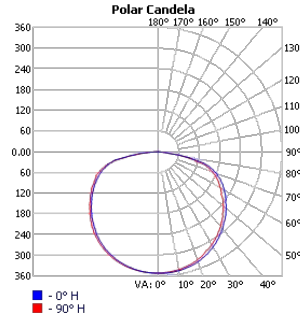

TECHOLED-ASR-D-14-ME-30

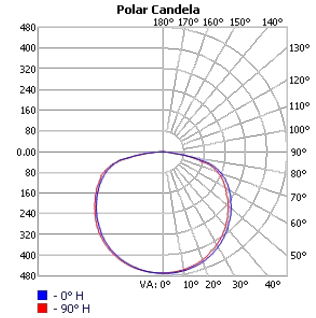

TECHOLED-ASR-D-14-HI-30

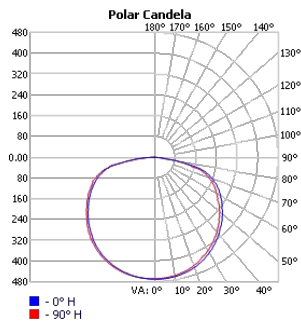

TECHOLED-ASR-D-17-LO-30

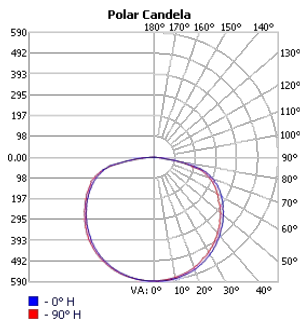

TECHOLED-ASR-D-17-ME-30

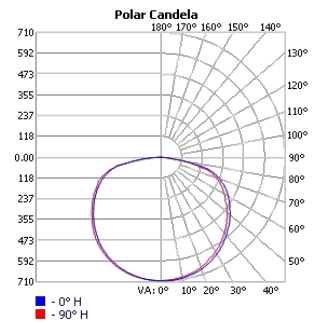

TECHOLED-ASR-D-17-HI-30

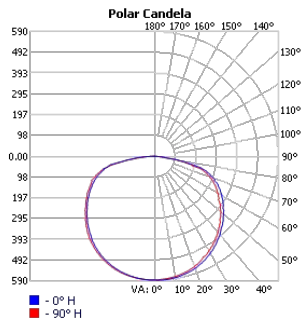

TECHOLED-ASR-D-23-LO-30

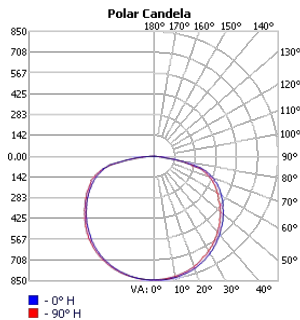

TECHOLED-ASR-D-23-ME-30

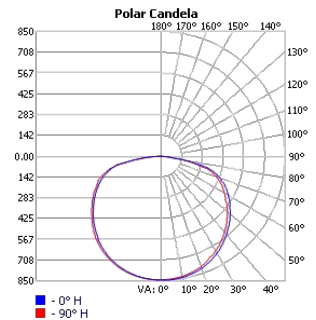

TECHOLED-ASR-D-23-HI-30

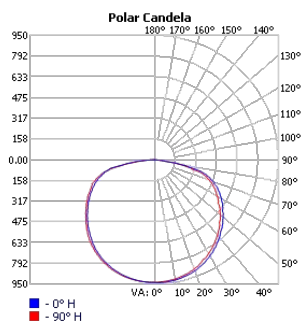

TECHOLED-ASR-D-31-LO-30

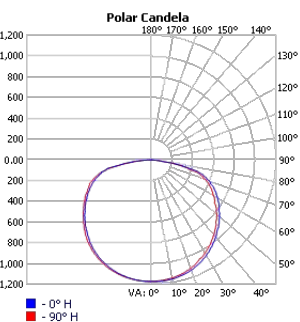

TECHOLED-ASR-D-31-ME-30

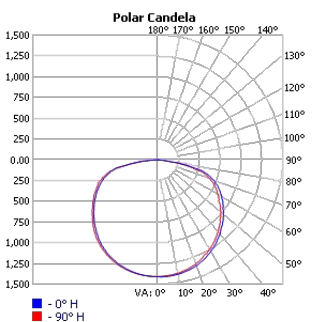

TECHOLED-ASR-D-31-HI-30

Project:	Type:
	Comments:

Finish Details (powder coat finish)

■ Standard Colors



■ Custom Colors

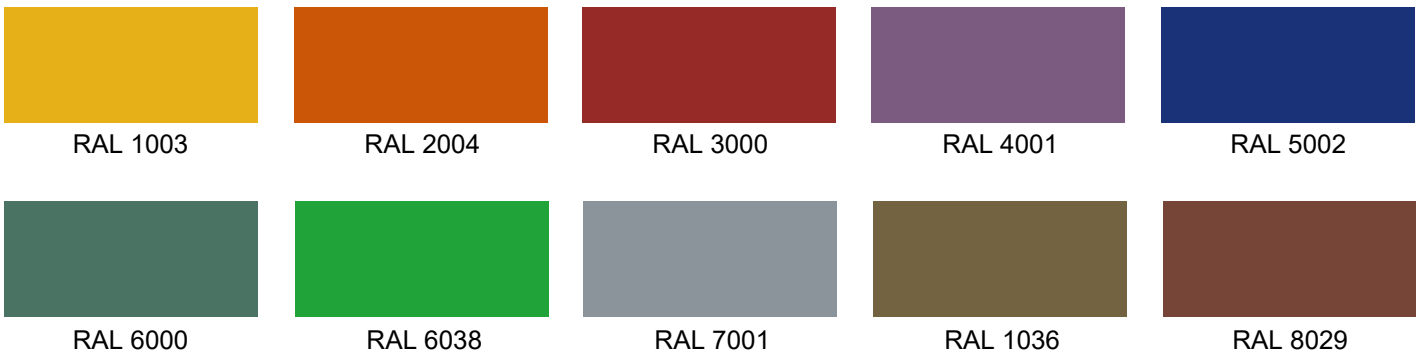

Any RAL color available, please refer to ralcolorchart.com

■ Custom Wooden Colors

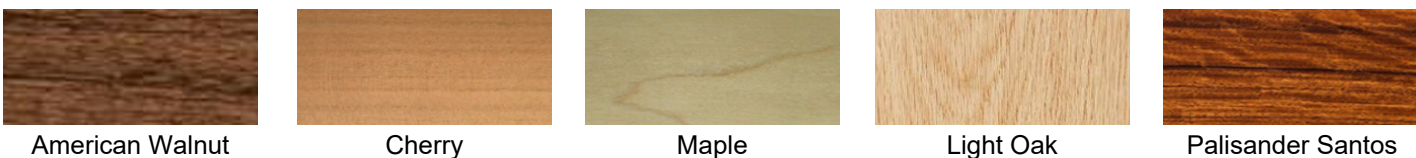

Project:	Type:
	Comments:

 **Acoustic color**

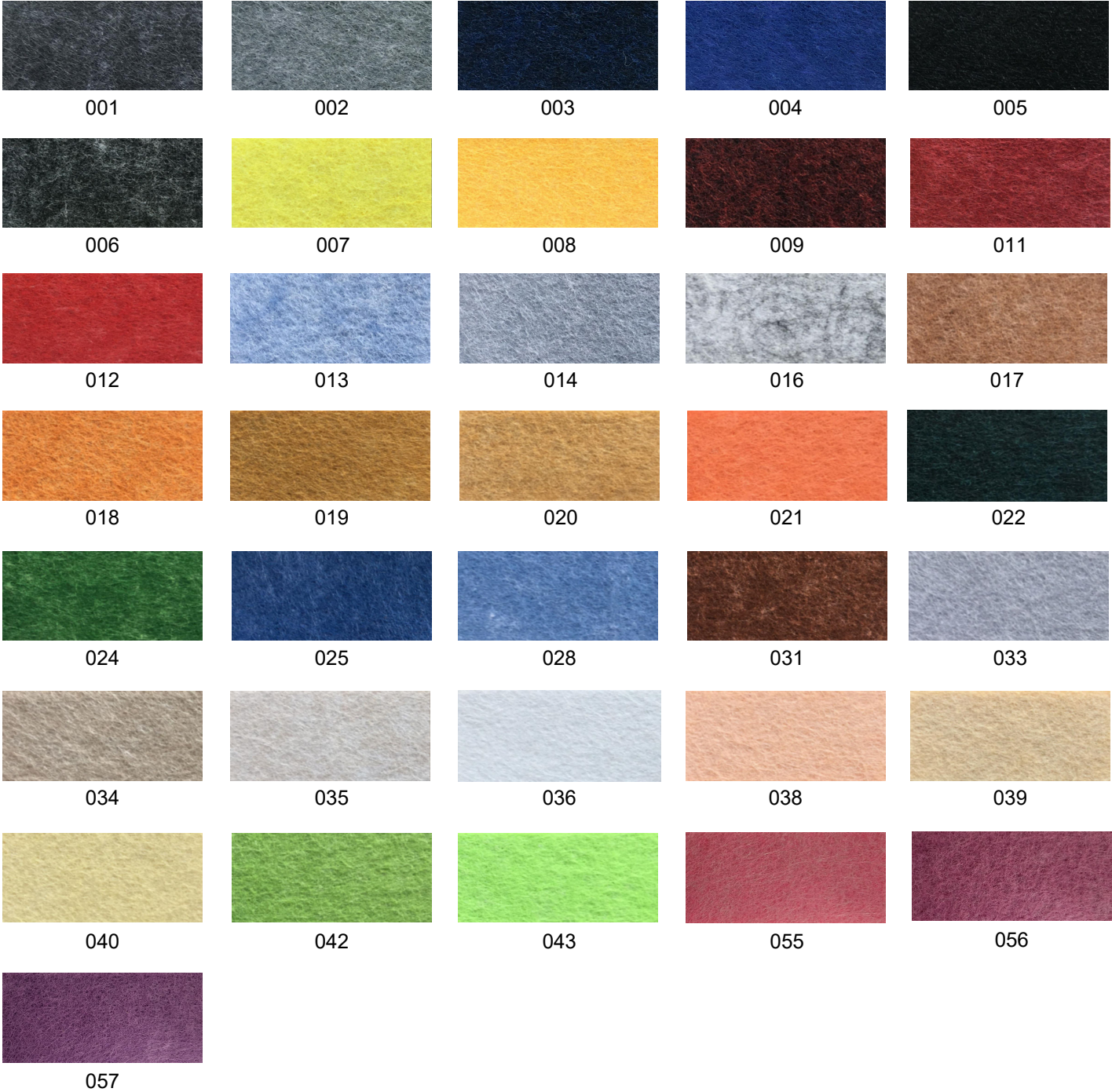

Project:	Type:
	Comments:

■ Acoustic faux wood texture



045



046

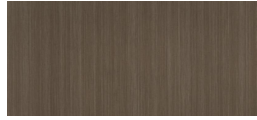

047

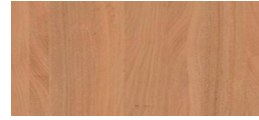

048



049



050



051

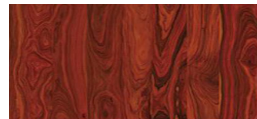

052



053



054