



### □ Highlights

The TechoLED BX series features specification-grade linear LED fixtures made from high-grade aluminum extrusions. Available in standard sizes from 2 to 8 feet, as well as custom lengths, these fixtures can be pendant, surface, or wall-mounted. With virtually limitless options for creating patterns and shapes, the BX series provides a versatile, cost-effective, and modern lighting solution.

**LED:** Samsung LED chips, 2700-5000K, tunable white and RGB/RGBW available, 90CRI, 50,000 hour rated lifespan. Custom lumen packages available.

**Optical:** Direct and direct/indirect illumination, 110° beam angle, UGR<19

**Construction:** Damp location listed, high grade aluminum extrusion, die cast end caps, PMMA diffuser, powder coat finish. X, T, L lit corners, wall to ceiling transitions, for smooth seamless patterns.

### □ Cross Section

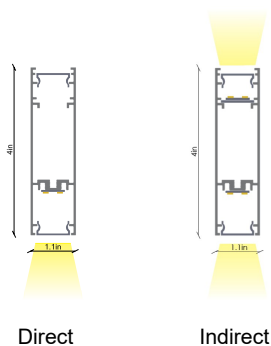

### □ Installation

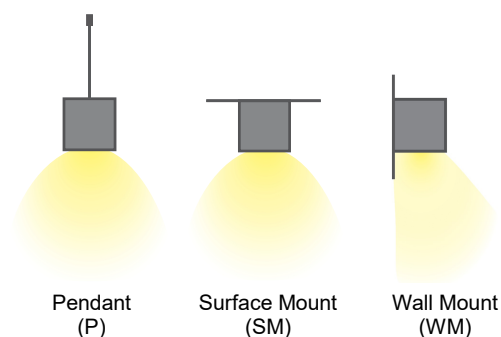

### Configuration Example

Model #	Distribution	Length	Lumen Output	Color Temp.	Voltage	Color
TECHOLED-BX-1-D-2-LO-27-U-W	Direct	2'	Low	2700K	110-277V	White

### Ordering Guide:

Select one option from each group below. For a custom preference please contact [sales@techoled.com](mailto:sales@techoled.com)

1-FIXTURE ID		2-DISTRIBUTION		3-LENGTH		4-LUMEN OUTPUT	
<b>BX-1</b>	BX-1	<b>D</b>	Direct	<b>2</b>	2'	<b>LO</b>	Low
		<b>DI</b>	Direct/Indirect	<b>4</b>	4'	<b>ME</b>	Medium
		<b>DI2</b>	D/I2-circuit	<b>6</b>	6'	<b>HI</b>	High
		<b>DWW</b>	Direct, Wall Wash	<b>8</b>	8'		
				<b>C</b>	Custom		

5-COLOR TEMP.		6-VOLTAGE		7-FINISH		8-MOUNTING	
<b>27</b>	2700K	<b>U</b>	110-277V	<b>S</b>	Silver	<b>P</b>	Pendant
<b>30</b>	3000K	<b>HV</b>	347V	<b>W</b>	White	<b>W</b>	Wall Mount
<b>35</b>	3500K			<b>B</b>	Black	<b>SM</b>	Surface Mount
<b>40</b>	4000K			<b>C</b>	Custom (RAL#)		
<b>50</b>	5000K						
<b>DT</b>	Lutron T-series						
<b>RGB</b>	RGB						
<b>RGBW</b>	RGBW						
<b>D</b>	Tunable White						

9-DRIVER OPTIONS		10-OPTIONS		11-OPTIONS (CONT.)	
<b>DM</b>	0-10V Dimming	<b>RF-D</b>	Remote Tunable (RF only)	<b>EM</b>	EM Battery (remote)
<b>2C</b>	2 Channel	<b>RF-R</b>	Remote RGB/W (RF only)	<b>X</b>	None
<b>DM1%</b>	1% Dimming	<b>M</b>	Motion Sensor (remote)		
<b>LT1</b>	LDE1 Lutron 1%	<b>BM</b>	BubblyNet BT Mesh		
<b>DA</b>	Dali	<b>CS</b>	Casambi		
<b>DMX</b>	DMX	<b>AWN</b>	Lutron Athena Node		
<b>TR</b>	Triac Dimming	<b>AWNS</b>	Lutron Athena Node sensor		
<b>RF</b>	RF Wireless	<b>NL-ES7</b>	nLight - Wired		
<b>X</b>	None	<b>NL-AIR</b>	nLight - AIR		
		<b>NL-M</b>	nLight - Module only		
		<b>X</b>	None		

--	--

### Lumen Output Details

Model #	Size	Output	Color Temp.	Wattage	Lumen Output
TECHOLED-BX-1-D-2-LO-30	2'	Low	3000K	11W	1140Lm
TECHOLED-BX-1-D-2-ME-30	2'	Medium	3000K	15W	1520Lm
TECHOLED-BX-1-D-2-HI-30	2'	High	3000K	20W	2000Lm
TECHOLED-BX-1-D-4-LO-30	4'	Low	3000K	23W	2280Lm
TECHOLED-BX-1-D-4-ME-30	4'	Medium	3000K	30W	3040Lm
TECHOLED-BX-1-D-4-HI-30	4'	High	3000K	40W	4000Lm
TECHOLED-BX-1-D-6-LO-30	6'	Low	3000K	34W	3420Lm
TECHOLED-BX-1-D-6-ME-30	6'	Medium	3000K	46W	4560Lm
TECHOLED-BX-1-D-6-HI-30	6'	High	3000K	60W	6000Lm
TECHOLED-BX-1-D-8-LO-30	8'	Low	3000K	46W	4560Lm
TECHOLED-BX-1-D-8-ME-30	8'	Medium	3000K	61W	6080Lm
TECHOLED-BX-1-D-8-HI-30	8'	High	3000K	80W	8000Lm

Performance above applies to 90 CRI, 3000K. Calculate 96% for 2700K, 104% for 3500K and 109% for 4000K

Model #	Size	Output	Color Temp.	Wattage	Down Lumen Out.	Up Lumen Out.
TECHOLED-BX-1-DI-2-LO-30	2'	Low	3000K	17W	1140Lm	570Lm
TECHOLED-BX-1-DI-2-ME-30	2'	Medium	3000K	23W	1520Lm	760Lm
TECHOLED-BX-1-DI-2-HI-30	2'	High	3000K	30W	2000Lm	1000Lm
TECHOLED-BX-1-DI-4-LO-30	4'	Low	3000K	34W	2280Lm	1140Lm
TECHOLED-BX-1-DI-4-ME-30	4'	Medium	3000K	46W	3040Lm	1520Lm
TECHOLED-BX-1-DI-4-HI-30	4'	High	3000K	60W	4000Lm	2000Lm
TECHOLED-BX-1-DI-6-LO-30	6'	Low	3000K	51W	3420Lm	1710Lm
TECHOLED-BX-1-DI-6-ME-30	6'	Medium	3000K	68W	4560Lm	2280Lm
TECHOLED-BX-1-DI-6-HI-30	6'	High	3000K	90W	6000Lm	3000Lm
TECHOLED-BX-1-DI-8-LO-30	8'	Low	3000K	68W	4560Lm	2280Lm
TECHOLED-BX-1-DI-8-ME-30	8'	Medium	3000K	91W	6080Lm	3040Lm
TECHOLED-BX-1-DI-8-HI-30	8'	High	3000K	120W	8000Lm	4000Lm

Performance above applies to 90 CRI, 3000K. Calculate 96% for 2700K, 104% for 3500K and 109% for 4000K

### Performance

Output	Direct			Indirect		
	Lumens / W	W / ft	Lumens / ft	Lumens / W	W / ft	Lumens / ft
Low	100	5.7	570	100	2.9	285
Medium	100	7.6	760	100	3.8	380
High	100	10	1000	100	5.0	500



### Driver Option Details

Code	Description
LT1	<b>LDE1</b> -Lutron Hi-lume 1% EcoSystem, Soft-on, Fade-to Black Dimming
DA	<b>DALI</b>
DMX	<b>DMX</b> - Decoder provided by TechoLED, controller by others

### Controls Details

Code	Description
RF-D	<b>RF Wireless</b> remote controller for tunable white. <b>Default for tunable white.</b>
RF-R	<b>RF Wireless</b> remote controller for RGB & RGBW. <b>Default for RGB &amp; RGBW.</b>
M	<b>Motion Sensor</b> - remote, for integral sensor consult factory
BM	<b>Bluetooth Mesh</b> Smart Wireless Control by BubblyNet
CS	<b>Bluetooth Mesh</b> Smart Wireless Control by Casambi
AWNR	<b>Lutron Athena</b> wireless node
AWNS	<b>Lutron Athena</b> wireless node with sensor
NL-ES7	<b>Acuity nLight</b> – Wired nES7 sensor
NL-AIR	<b>Acuity nLight</b> – AIR wireless rES7 sensor
NL-M	<b>Acuity nLight</b> - ready, sensor by others

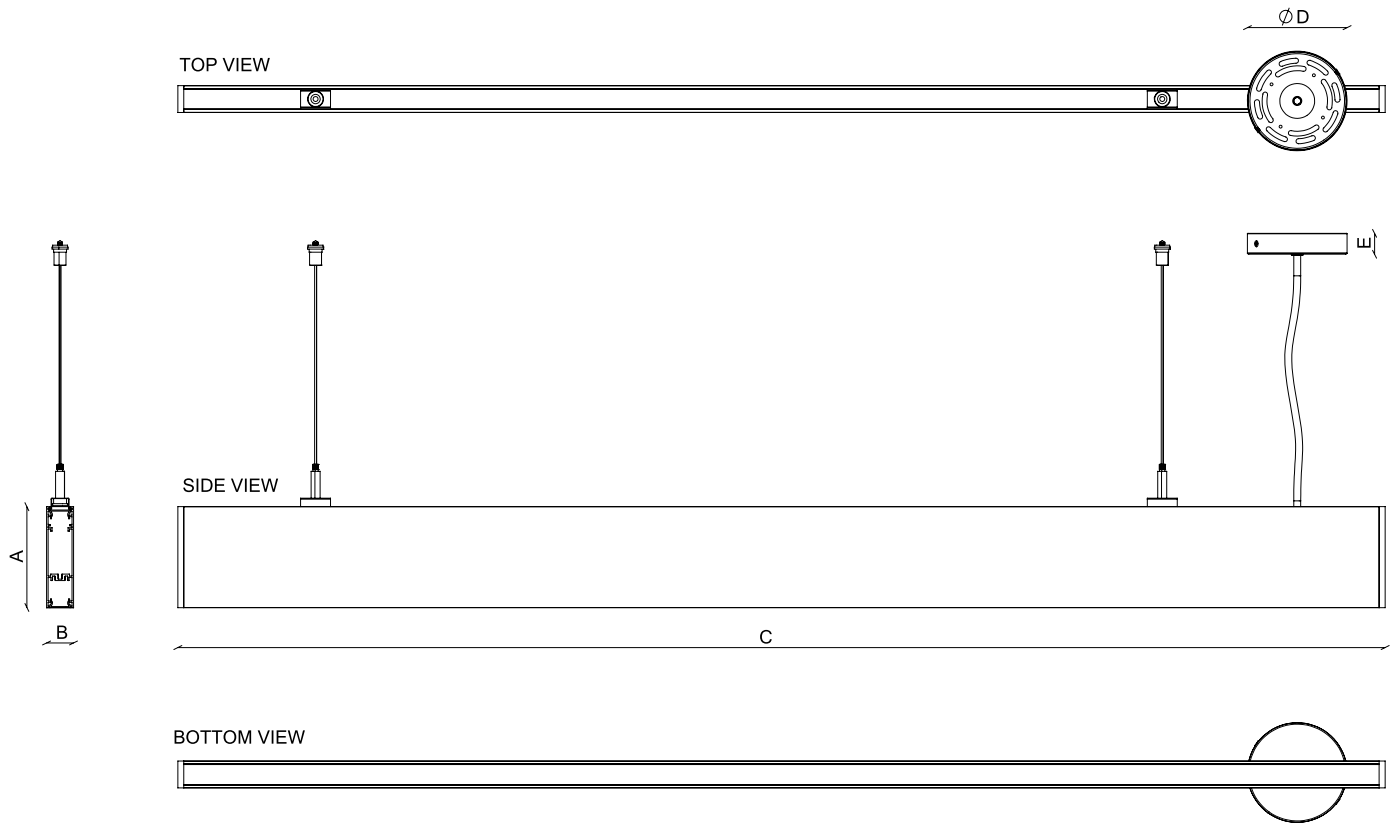
### □ Dimension and Mounting - Direct Distribution (D)



FIXTURE ID	A	B	C	D	E
BX-1-D-2	4"	1.1"	24"	4.33"	0.98"
BX-1-D-4	4"	1.1"	48"	4.33"	0.98"
BX-1-D-6	4"	1.1"	72"	4.33"	0.98"
BX-1-D-8	4"	1.1"	96"	4.33"	0.98"

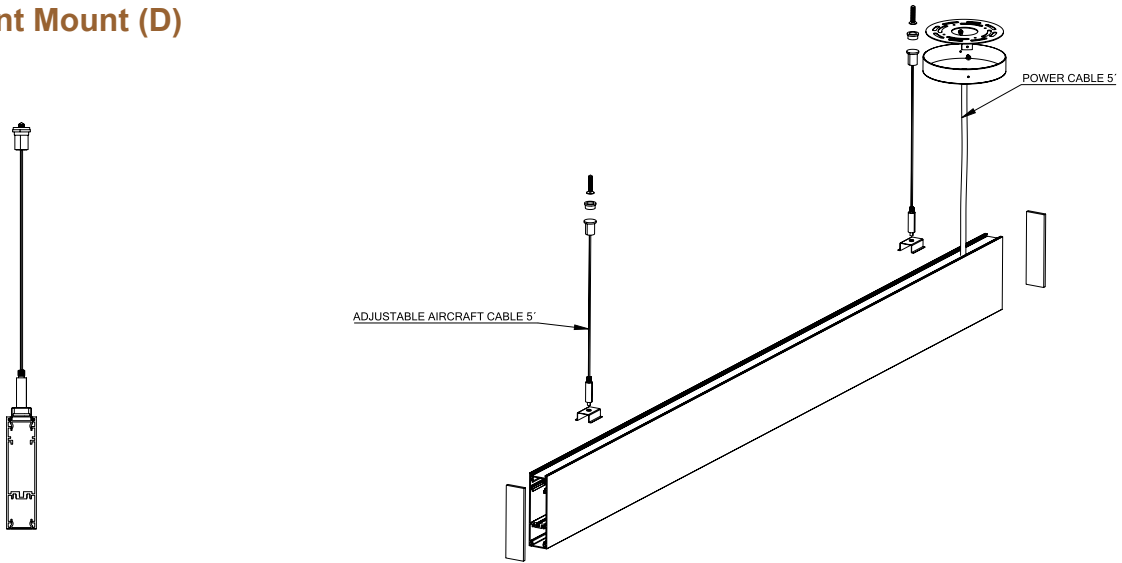

### ■ Pendant Mount (D)

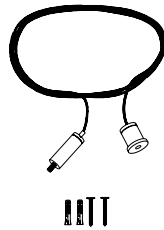

### ■ Pendant Kit

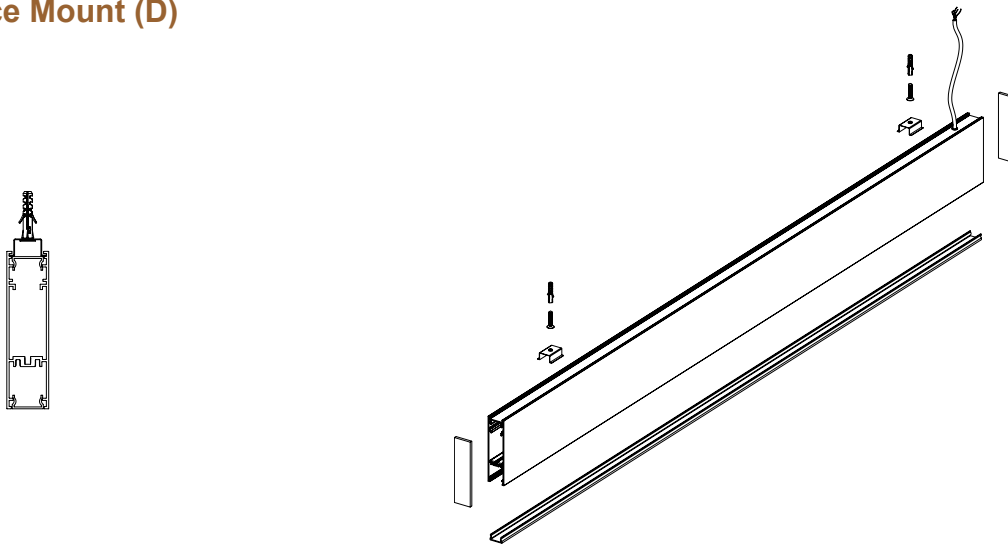

### ■ Surface Mount (D)



### ■ Surface Mount Kit

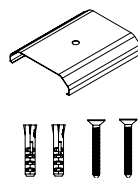

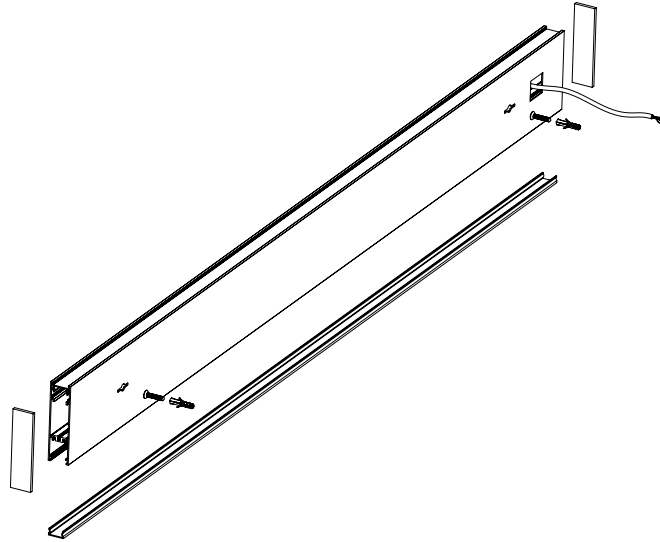
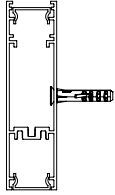

### ■ Wall Mount (D)

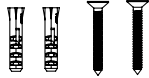

### ■ Wall Mount Kit



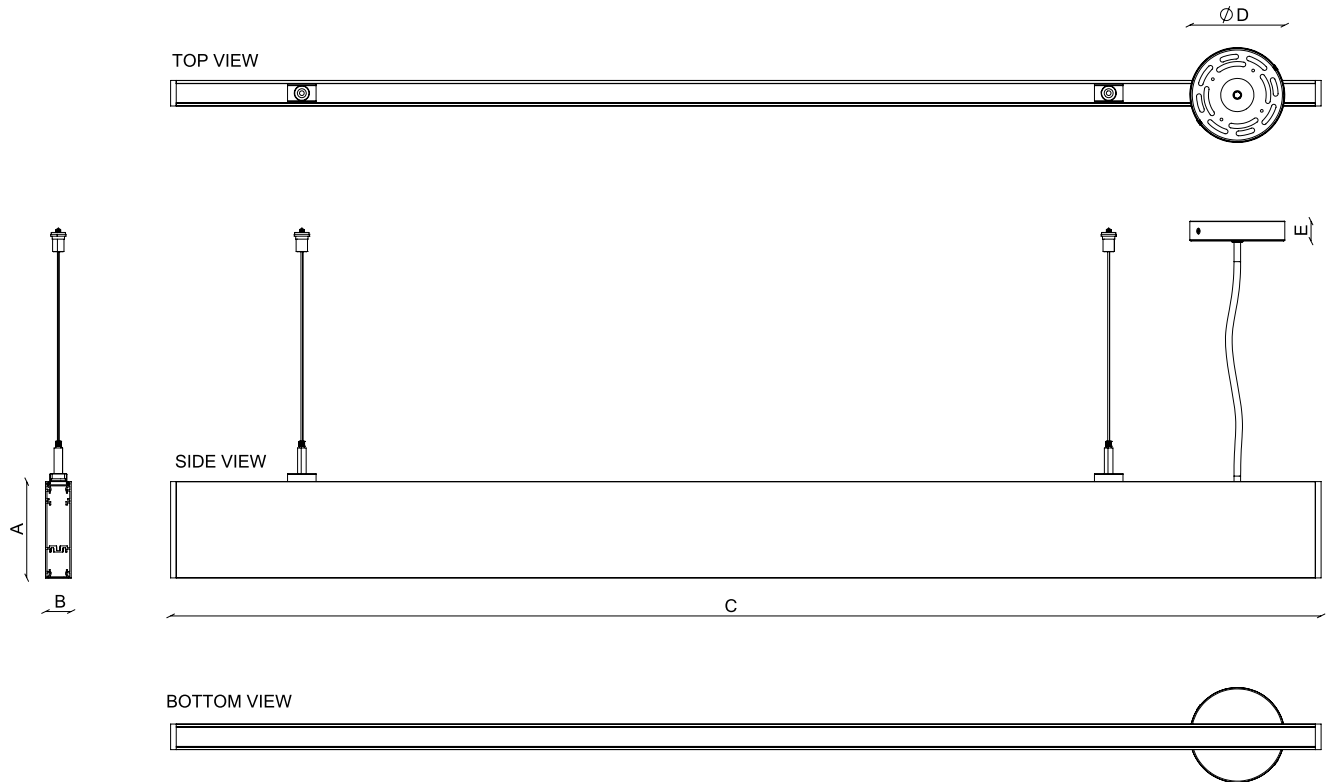

### Dimension and Mounting - Direct/Indirect Distribution (DI)



FIXTURE ID	A	B	C	D	E
BX-1-DI-2	4"	1.1"	24"	4.33"	0.98"
BX-1-DI-4	4"	1.1"	48"	4.33"	0.98"
BX-1-DI-6	4"	1.1"	72"	4.33"	0.98"
BX-1-DI-8	4"	1.1"	96"	4.33"	0.98"

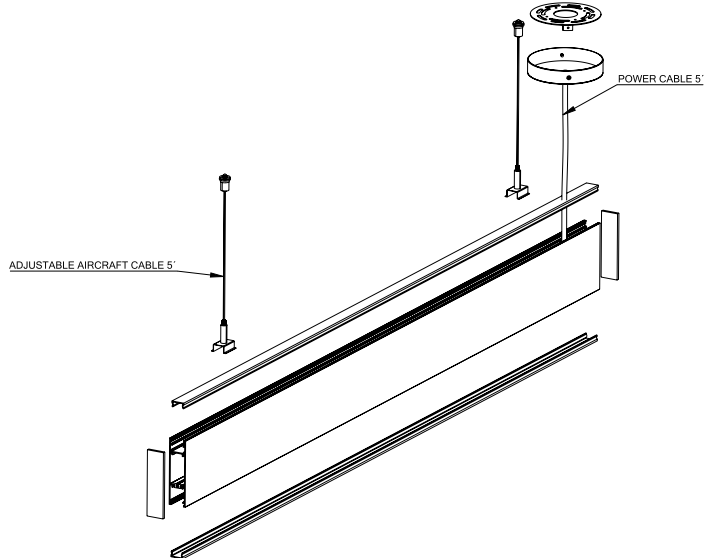

### ■ Pendant Mount (DI)

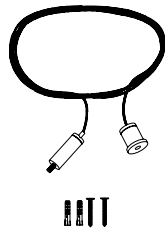

### ■ Pendant Kit

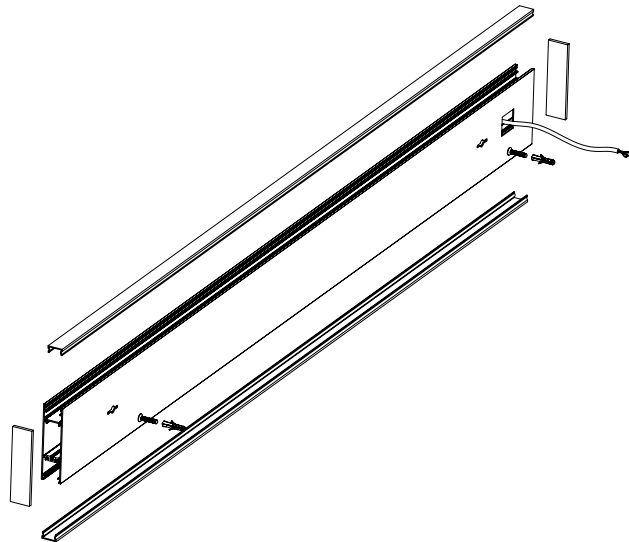
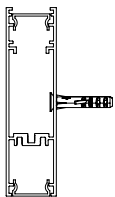

### ■ Wall Mount (DI)



### ■ Wall Mount Kit

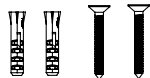

### Connectors

#### ■ BX-1 (T-shape) - connector

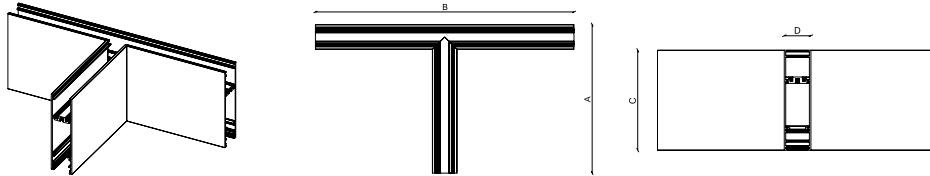

(T-shape)	Connector
A	6.4"
B	11.2"
C	4"
D	1.1"

*Not to scale*

#### ■ BX-1 (L-shape) - connector

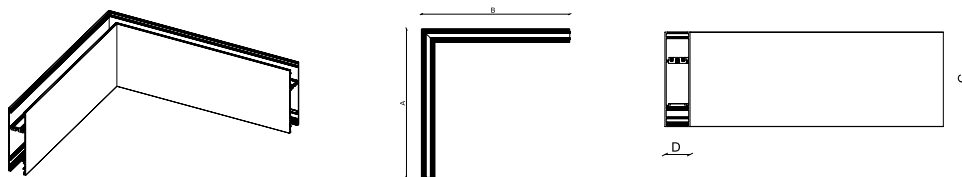

(L-shape)	Connector
A	11.8"
B	11.8"
C	4"
D	1.1"

*Not to scale*

#### ■ BX-1 (X-shape) - connector

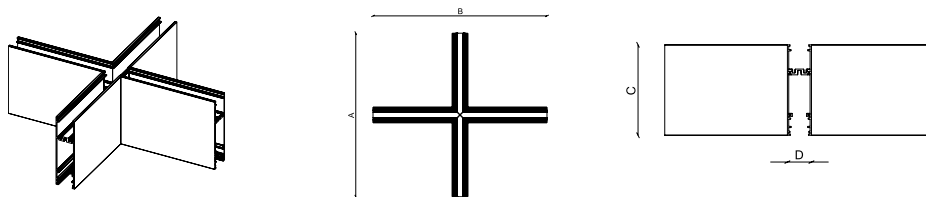

(X-shape)	Connector
A	11.2"
B	11.89"
C	4"
D	1.1"

*Not to scale*

#### ■ BX-1 (Y-shape) - connector

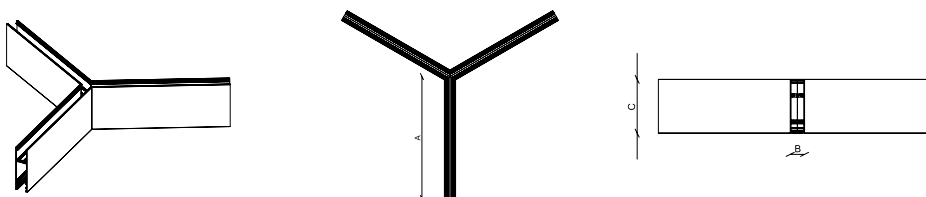

(Y-shape)	Connector
A	11.6"
B	6"
C	4"
D	1.1"

*Not to scale*

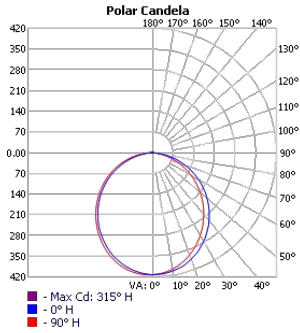

**Photometrics**

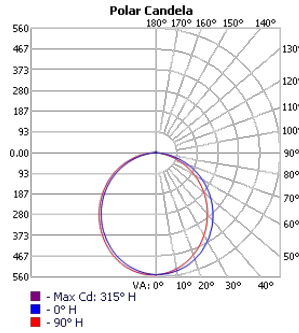

TECHOLED-BX-1-D-2-LO-30

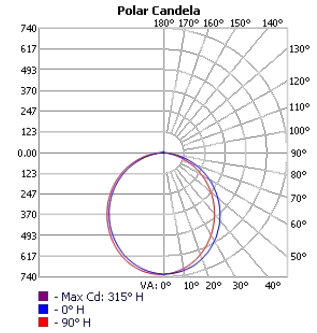

TECHOLED-BX-1-D-2-ME-30



TECHOLED-BX-1-D-2-HI-30

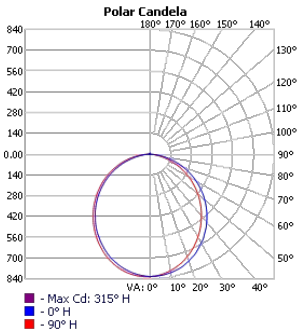

TECHOLED-BX-1-D-4-LO-30

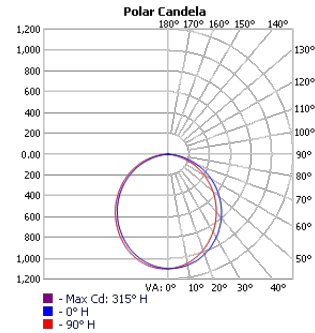

TECHOLED-BX-1-D-4-ME-30

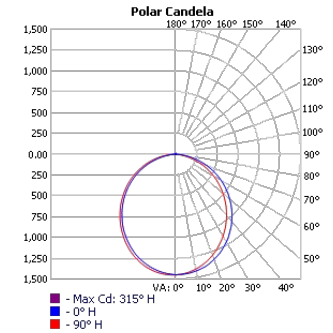

TECHOLED-BX-1-D-4-HI-30

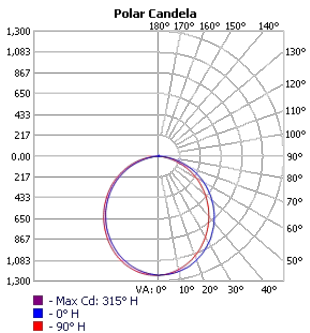

TECHOLED-BX-1-D-6-LO-30

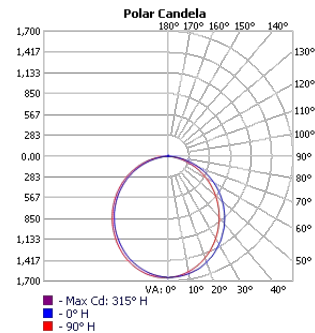

TECHOLED-BX-1-D-6-ME-30

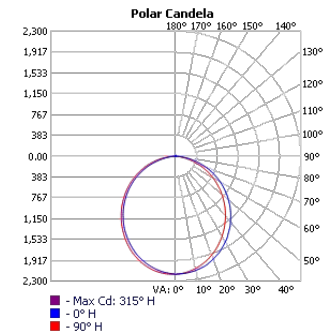

TECHOLED-BX-1-D-6-HI-30

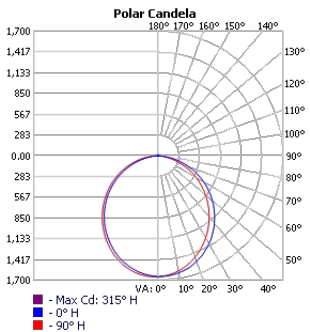

TECHOLED-BX-1-D-8-LO-30

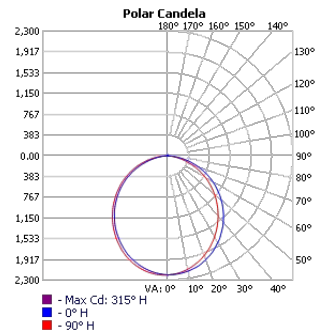

TECHOLED-BX-1-D-8-ME-30

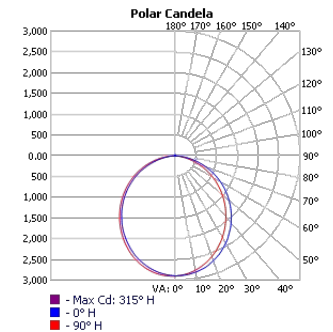

TECHOLED-BX-1-D-8-HI-30

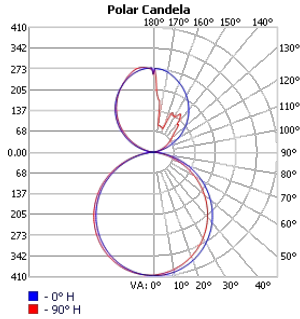
TECHOLED-BX-1-DI-2-LO-30

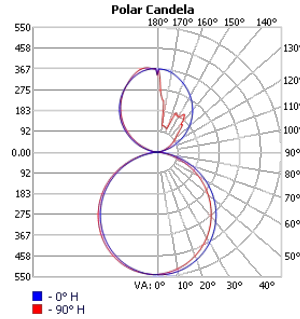

TECHOLED-BX-1-DI-2-ME-30

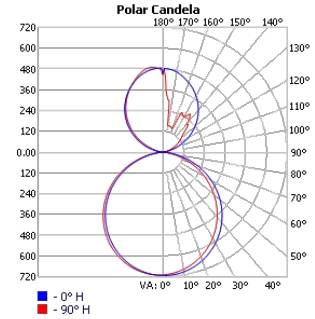

TECHOLED-BX-1-DI-2-HI-30

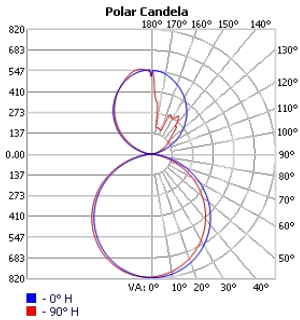

TECHOLED-BX-1-DI-4-LO-30

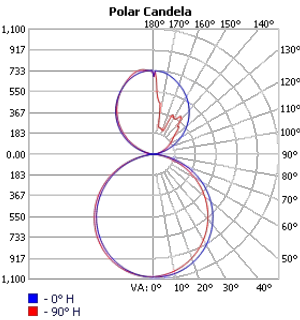

TECHOLED-BX-1-DI-4-ME-30

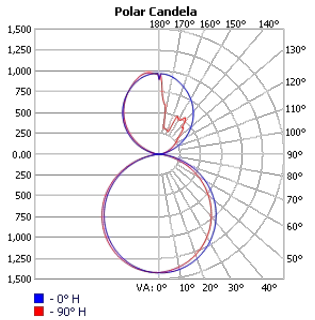

TECHOLED-BX-1-DI-4-HI-30

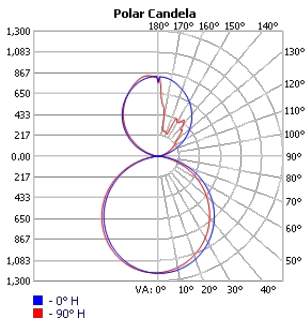

TECHOLED-BX-1-DI-6-LO-30

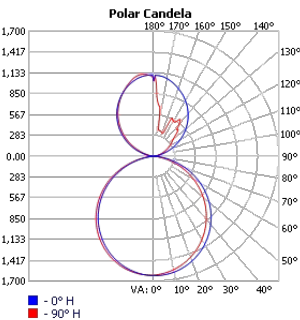

TECHOLED-BX-1-DI-6-ME-30

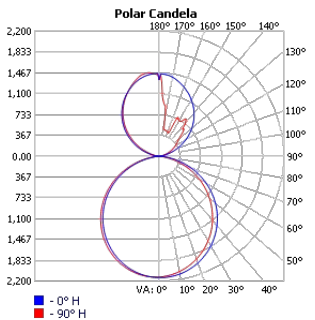

TECHOLED-BX-1-DI-6-HI-30

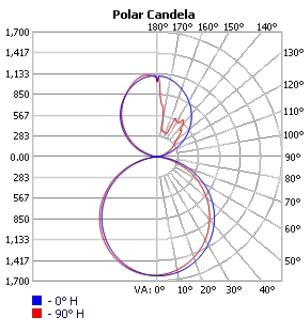

TECHOLED-BX-1-DI-8-LO-30

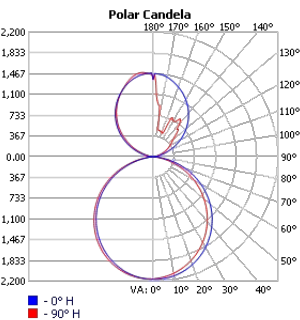

TECHOLED-BX-1-DI-8-ME-30

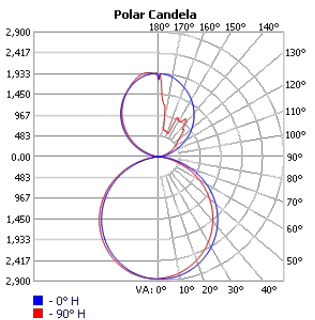

TECHOLED-BX-1-DI-8-HI-30

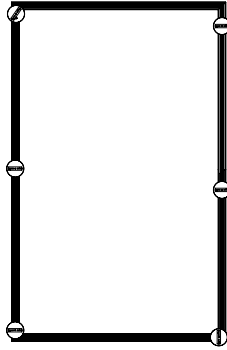

### Patterns Option Examples

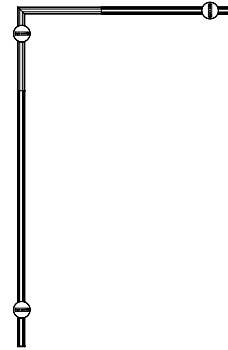

Rectangle

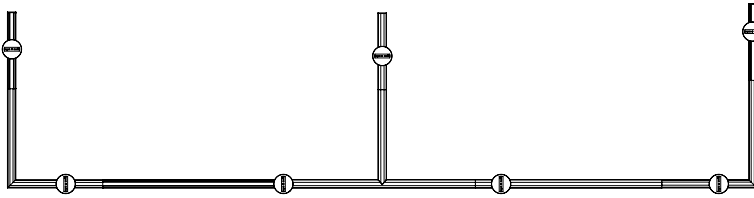

L-Shape



Custom

### Finish Details (powder coat finish)

#### ■ Standard Colors

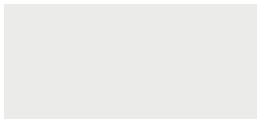

W – White



S – Silver



B – Black

#### ■ Custom Colors



RAL 1003



RAL 2004



RAL 3000



RAL 4001



RAL 5002



RAL 6000



RAL 6038



RAL 7001



RAL 1036



RAL 8029

Any RAL color available, please refer to [ralcolorchart.com](http://ralcolorchart.com)

#### ■ Custom Wooden Colors



American Walnut

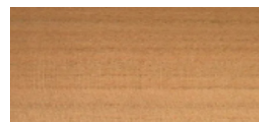

Cherry

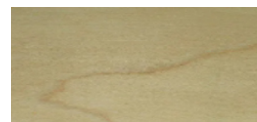

Maple



Light Oak



Palisander Santos

### Color Temperature

#### Color Temperature

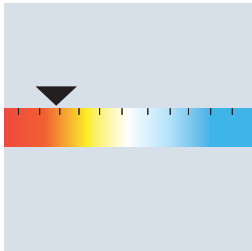

2700K

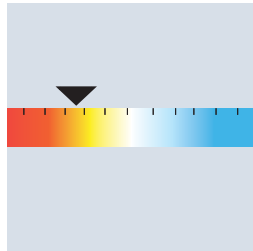

3000K

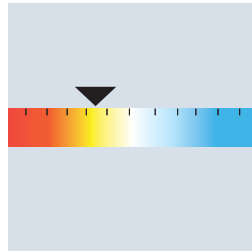

3500K

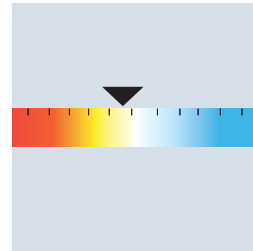

4000K

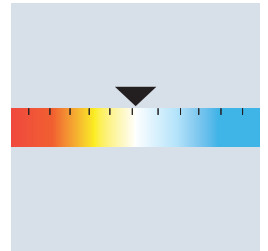

5000K

#### Tunable White

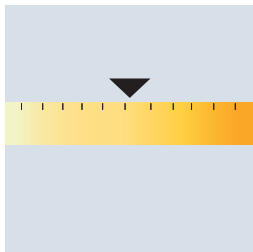

Dim To Warm

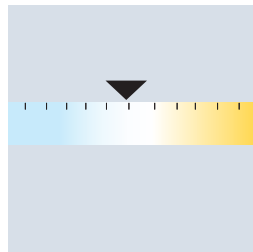

Tunable White