

Project:	Type:
	Comments:

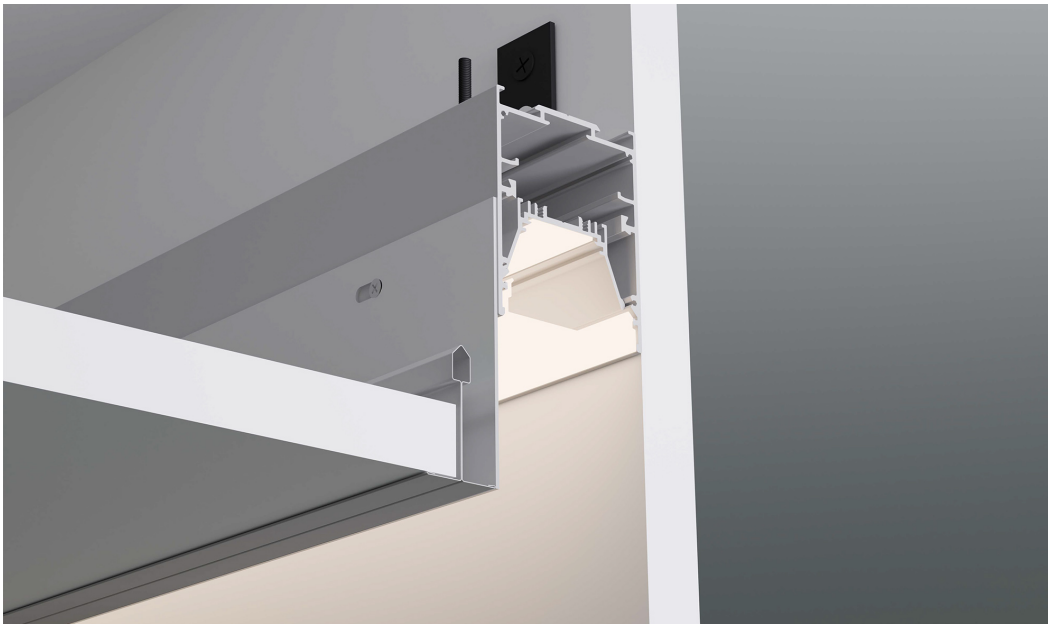

### ▣ Highlights

BX-2P Perimeter linear lighting is a highly versatile and effective lighting technique that offers a wide range of benefits for both residential and commercial spaces. It's not just about illumination; it's a design tool that can dramatically change the look and feel of a room.

**LED:** Samsung LED chips, 2700-5000K, tunable white and RGB/W available, 90CRI

**Optical:** Direct illumination, 110° beam angle

**Construction:** High grade aluminum extrusion, die cast end caps, PMMA diffuser, integral driver, powder coat finish, X, T, L Lit corners available for smooth, seamless patterns, damp location listed.

### ▣ Cross Section

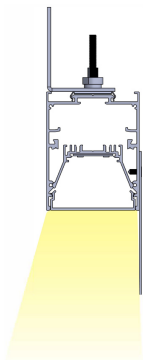

### ▣ Installation



Recessed Perimeter (RP)

Project:	Type:
	Comments:

### Configuration Example

Model #	Distribution	Length	Lumen Output	Color Temp.	Voltage	Finish
TECHOLED-BX-2P-D-2-LO-27-U-W	Direct	2'	Low	2700K	110-277V	White

### Ordering Guide:

Select one option from each group below. For a custom preference please contact [sales@techoled.com](mailto:sales@techoled.com)

1-FIXTURE ID	2-DISTRIBUTION	3-LENGTH	4-LUMEN OUTPUT
<b>BX-2-P</b> BX-2-P	<b>D</b> Direct	<b>2</b> 2' <b>4</b> 4' <b>6</b> 6' <b>8</b> 8' <b>C</b> Custom	<b>LO</b> Low <b>ME</b> Medium <b>HI</b> High

5-COLOR TEMP.	6-VOLTAGE	7-FINISH	8-MOUNTING
<b>27</b> 2700K <b>30</b> 3000K <b>35</b> 3500K <b>40</b> 4000K <b>50</b> 5000K <b>DT</b> Lutron T-series <b>RGB</b> RGB <b>RGBW</b> RGBW <b>D</b> Tunable White	<b>U</b> 110-277V <b>HV</b> 347V	<b>S</b> Silver <b>W</b> White <b>B</b> Black <b>C</b> Custom (RAL#)	<b>PE</b> Perimeter

9-DRIVER OPTIONS	10-OPTIONS	11-OPTIONS (CONT.)
<b>DM</b> 0-10V Dimming <b>2C</b> 2 Channel <b>DM1%</b> 1% Dimming <b>LT1</b> LDE1 Lutron 1% <b>DA</b> Dali <b>DMX</b> DMX <b>TR</b> Triac Dimming <b>RF</b> RF Wireless <b>X</b> None	<b>RF-D</b> Remote Tunable (RF only) <b>RF-R</b> Remote RGB/W (RF only) <b>M</b> Motion Sensor (remote) <b>BM</b> BubblyNet BT Mesh <b>CS</b> Casambi <b>AWNR</b> Lutron Athena Node <b>AWNS</b> Lutron Athena Node sensor <b>NL-ES7</b> nLight - Wired <b>NL-AIR</b> nLight - AIR <b>NL-M</b> nLight - Module only <b>X</b> None	<b>EM</b> EM Battery (remote) <b>X</b> None

Project:	Type:
	Comments:

### Lumen Output Details

Model #	Size	Output	Color Temp.	Wattage	Lumen Output
TECHOLED-BX-2P-D-2-LO-30	2'	Low	3000K	11W	1100Lm
TECHOLED-BX-2P-D-2-ME-30	2'	Medium	3000K	16W	1600Lm
TECHOLED-BX-2P-D-2-HI-30	2'	High	3000K	20W	2000Lm
TECHOLED-BX-2P-D-4-LO-30	4'	Low	3000K	22W	2200Lm
TECHOLED-BX-2P-D-4-ME-30	4'	Medium	3000K	31W	3100Lm
TECHOLED-BX-2P-D-4-HI-30	4'	High	3000K	40W	4000Lm
TECHOLED-BX-2P-D-6-LO-30	6'	Low	3000K	33W	3300Lm
TECHOLED-BX-2P-D-6-ME-30	6'	Medium	3000K	46W	4600Lm
TECHOLED-BX-2P-D-6-HI-30	6'	High	3000K	60W	6000Lm
TECHOLED-BX-2P-D-8-LO-30	8'	Low	3000K	46W	4600Lm
TECHOLED-BX-2P-D-8-ME-30	8'	Medium	3000K	61W	6100Lm
TECHOLED-BX-2P-D-8-HI-30	8'	High	3000K	80W	8000Lm

Performance above applies to 90 CRI, 3000K. Calculate 96% for 2700K, 104% for 3500K and 109% for 4000K

### Performance

Output Direct	Direct	
	Lumens / W	Lumens / ft
Low	100	550
Medium	100	770
High	100	1000

Project:	Type:
	Comments:

### Driver Option Details

Code	Description
LT1	<b>LDE1</b> - Lutron Hi-lume 1% EcoSystem, Soft-on, Fade-to Black Dimming
DA	<b>DALI</b>
DMX	<b>DMX</b> - Decoder provided by TechoLED, controller by others

### Controls Details

Code	Description
RF-D	<b>RF Wireless</b> remote controller for tunable white. <b>Default for tunable white.</b>
RF-R	<b>RF Wireless</b> remote controller for RGB & RGBW. <b>Default for RGB &amp; RGBW.</b>
M	<b>Motion Sensor</b> - remote, for integral sensor consult factory
BM	<b>Bluetooth Mesh</b> Smart Wireless Control by BubblyNet
CS	<b>Bluetooth Mesh</b> Smart Wireless Control by Casambi
AWNR	<b>Lutron Athena</b> wireless node
AWNS	<b>Lutron Athena</b> wireless node with sensor
NL-ES7	<b>Acuity nLight</b> - Wired nES7 sensor
NL-AIR	<b>Acuity nLight</b> - AIR wireless rES7 sensor
NL-M	<b>Acuity nLight</b> - ready, sensor by others

Project:	Type:
	Comments:

**□ Perimeter to T- grid**

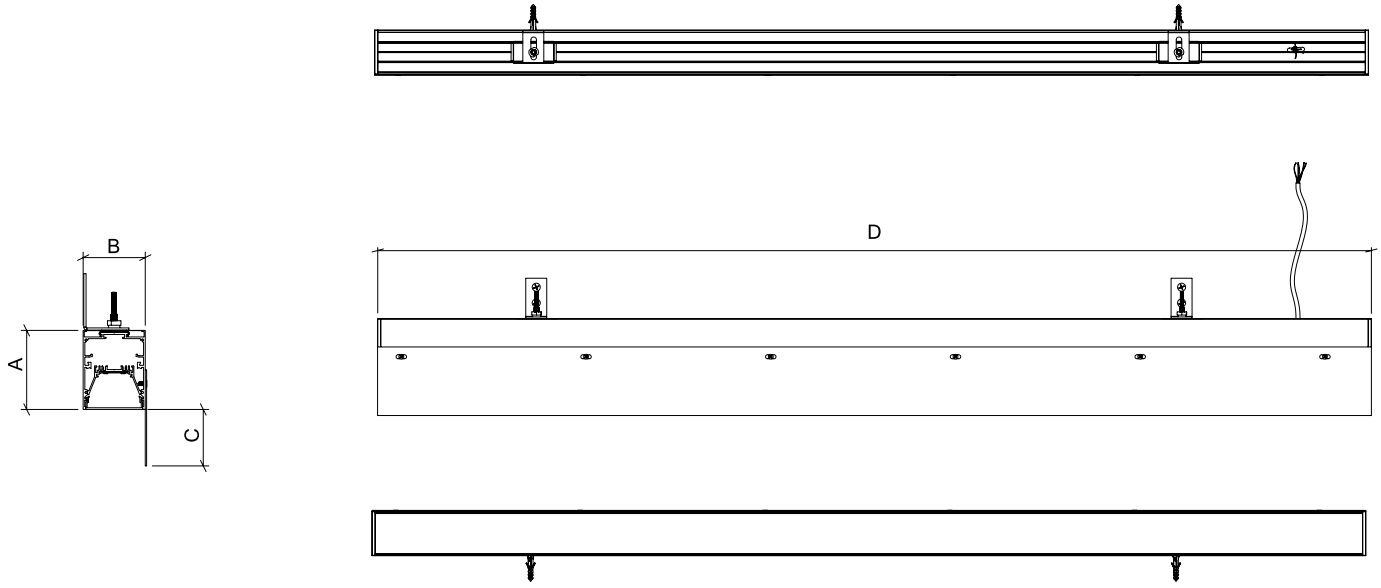

FIXTURE ID	A	B	C	D
BX-2P-D-2	2.76"	2.17"	2"	24"
BX-2P-D-4	2.76"	2.17"	2"	48"
BX-2P-D-6	2.76"	2.17"	2"	72"
BX-2P-D-8	2.76"	2.17"	2"	96"

Project:	Type:
	Comments:

### ■ Perimeter to T- grid

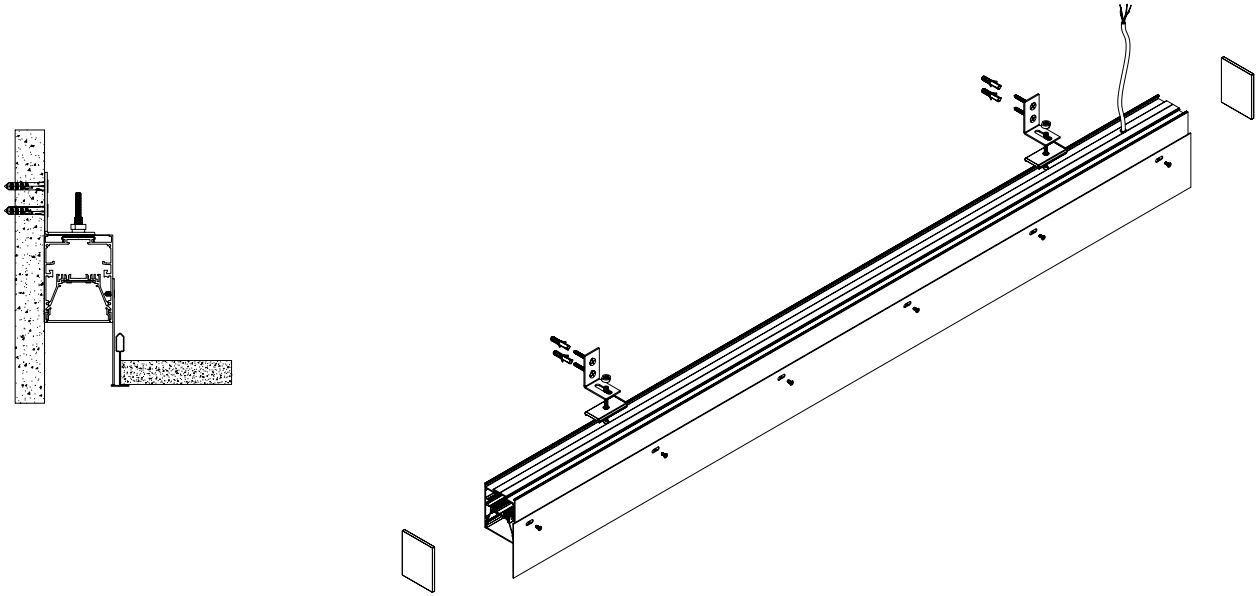

### Perimeter to T- grid Kit

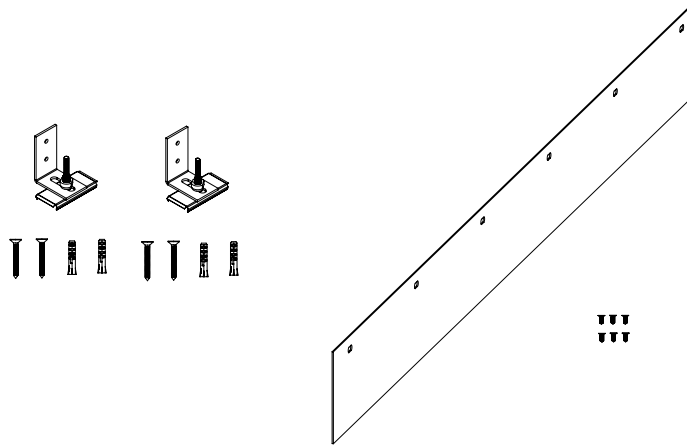

Project:	Type:
	Comments:

### Connectors

#### BX-2P L-shape

BX-2P-L	Connector
A	25.08"
B	25.08"
C	2.76"
D	2.17"

Not to scale

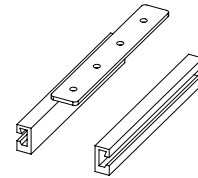
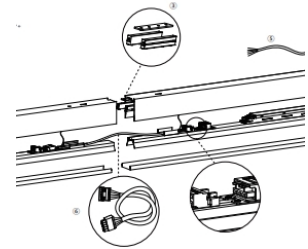
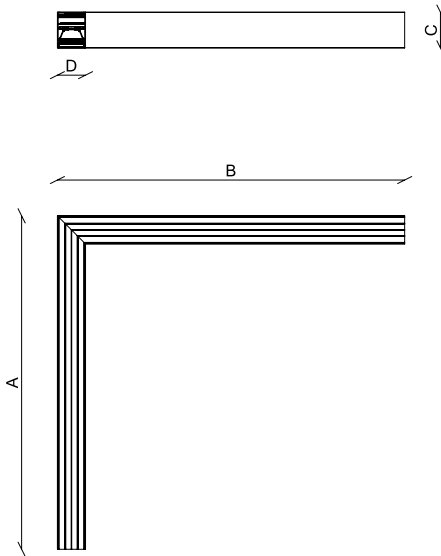
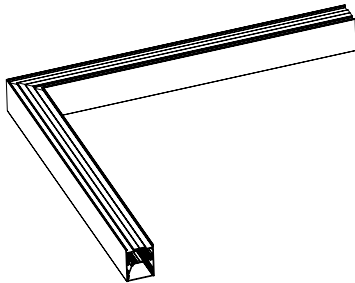

L45-180

Project:	Type:
	Comments:

### Photometrics

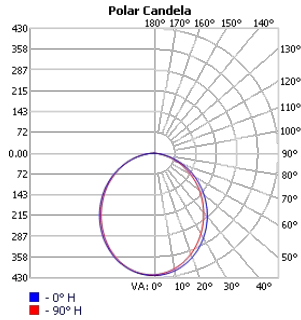

TECHOLED-BX-2P-D-2-LO-30

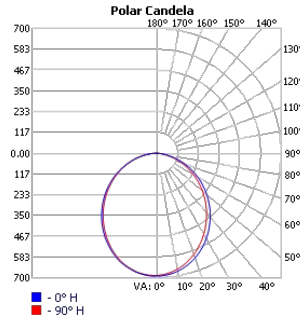

TECHOLED-BX-2P-D-2-ME-30

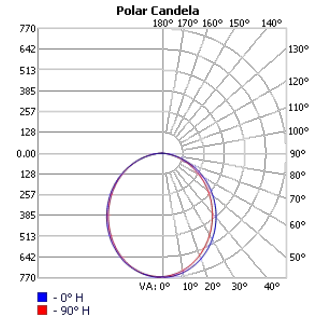

TECHOLED-BX-2P-D-2-HI-30

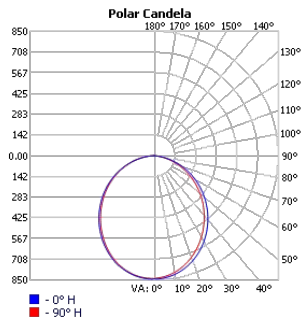

TECHOLED-BX-2P-D-4-LO-30

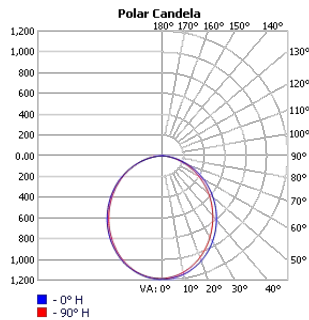

TECHOLED-BX-2P-D-4-ME-30

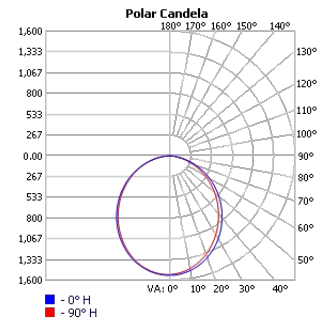

TECHOLED-BX-2P-D-4-HI-30

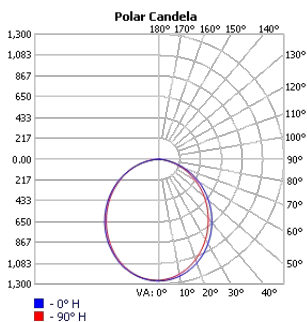

TECHOLED-BX-2P-D-6-LO-30

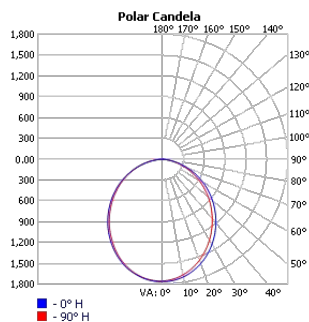

TECHOLED-BX-2P-D-6-ME-30

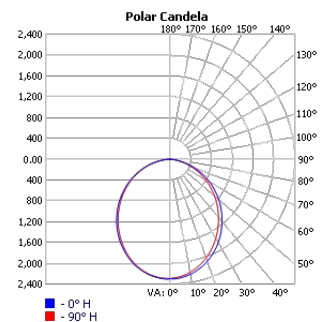

TECHOLED-BX-2P-D-6-HI-30

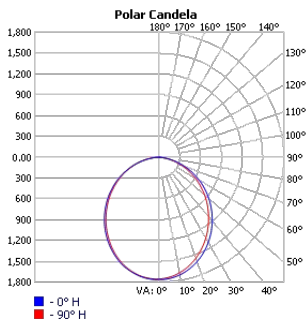

TECHOLED-BX-2P-D-8-LO-30

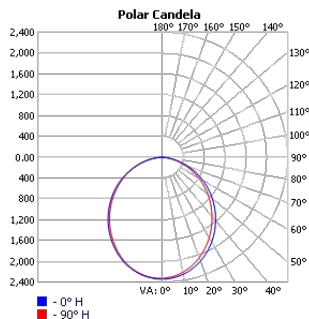

TECHOLED-BX-2P-D-8-ME-30

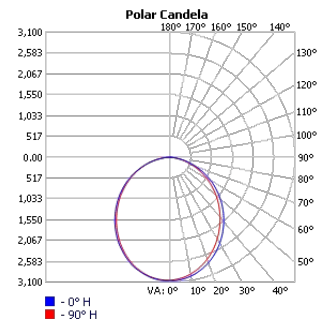

TECHOLED-BX-2P-D-8-HI-30

Project:	Type:
	Comments:

**Patterns Option Examples**

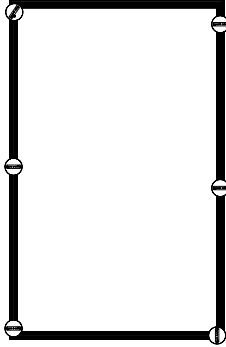

Rectangle

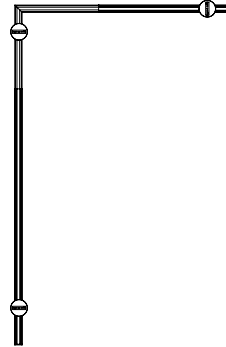

L-Shape

Project:	Type:
	Comments:

### Finish Details (powder coat finish)

#### ■ Standard Colors

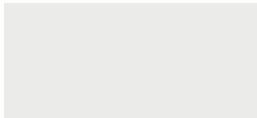

W – White



S – Silver



B – Black

#### ■ Custom Colors



RAL 1003



RAL 2004



RAL 3000



RAL 4001



RAL 5002



RAL 6000



RAL 6038



RAL 7001



RAL 1036



RAL 8029

Any RAL color available, please refer to [ralcolorchart.com](http://ralcolorchart.com)

#### ■ Custom Wooden Colors



American Walnut

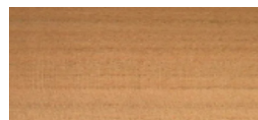

Cherry

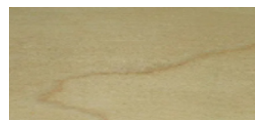

Maple



Light Oak



Palisander Santos

Project:	Type:
	Comments:

### Color Temperature

#### Color Temperature

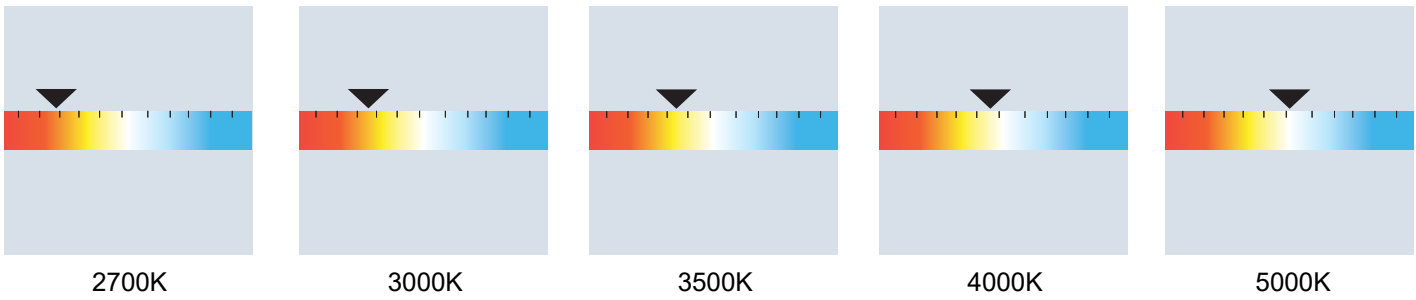

#### Tunable White

