

Project:	Type:
	Comments:

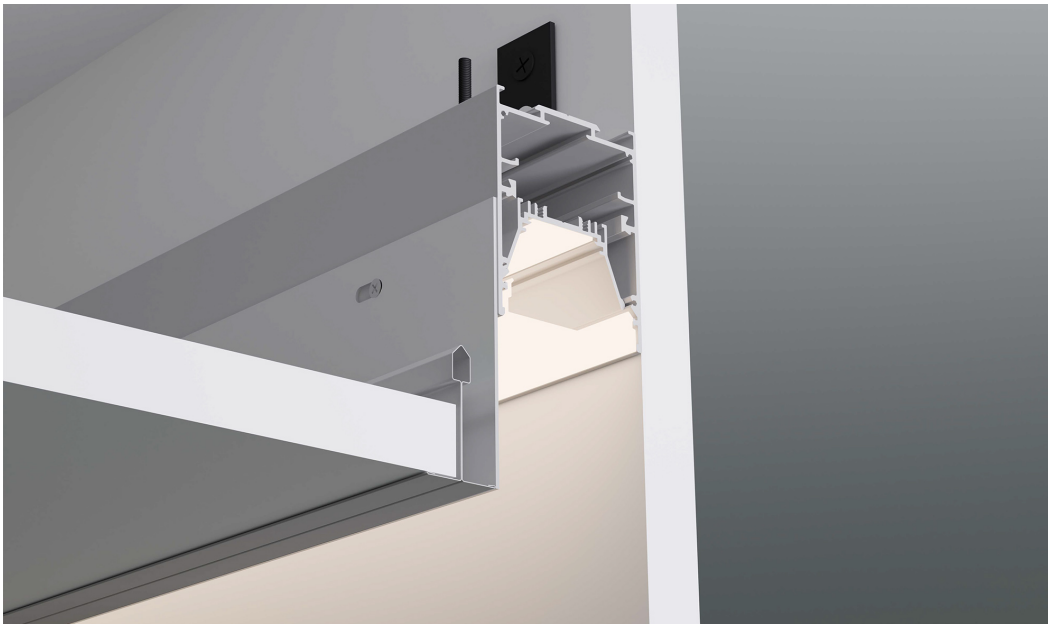

▣ Highlights

BX-2P Perimeter linear lighting is a highly versatile and effective lighting technique that offers a wide range of benefits for both residential and commercial spaces. It's not just about illumination; it's a design tool that can dramatically change the look and feel of a room.

LED: Samsung LED chips, 2700-5000K, tunable white and RGB/W available, 90CRI

Optical: Direct illumination, 110° beam angle

Construction: High grade aluminum extrusion, die cast end caps, PMMA diffuser, integral driver, powder coat finish, X, T, L Lit corners available for smooth, seamless patterns, damp location listed.

▣ Cross Section

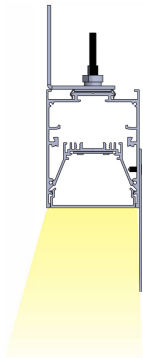

▣ Installation



Recessed Perimeter (RP)

Project:	Type:
	Comments:

Configuration Example

Model #	Distribution	Length	Lumen Output	Color Temp.	Voltage	Finish
TECHOLED-BX-2P-D-2-LO-27-U-W	Direct	2'	Low	2700K	110-277V	White

Ordering Guide:

Select one option from each group below. For a custom preference please contact sales@techoled.com

1-FIXTURE ID	2-DISTRIBUTION	3-LENGTH	4-LUMEN OUTPUT
BX-2-P BX-2-P	D Direct	2 2' 4 4' 6 6' 8 8' C Custom	LO Low ME Medium HI High

5-COLOR TEMP.	6-VOLTAGE	7-FINISH	8-MOUNTING
27 2700K 30 3000K 35 3500K 40 4000K 50 5000K DT Lutron T-series RGB RGB RGBW RGBW D Tunable White	U 110-277V HV 347V	S Silver W White B Black C Custom (RAL#)	PE Perimeter

9-DRIVER OPTIONS	10-OPTIONS	11-OPTIONS (CONT.)
DM 0-10V Dimming 2C 2 Channel DM1% 1% Dimming LT1 LDE1 Lutron 1% DA Dali DMX DMX TR Triac Dimming RF RF Wireless X None	RF-D Remote Tunable (RF only) RF-R Remote RGB/W (RF only) M Motion Sensor (remote) BM BubblyNet BT Mesh CS Casambi AWN Lutron Athena Node AWNS Lutron Athena Node sensor NL-ES7 nLight - Wired NL-AIR nLight - AIR NL-M nLight - Module only X None	EM EM Battery (remote) X None

Project:	Type:
	Comments:

Lumen Output Details

Model #	Size	Output	Color Temp.	Wattage	Lumen Output
TECHOLED-BX-2P-D-2-LO-30	2'	Low	3000K	11W	1100Lm
TECHOLED-BX-2P-D-2-ME-30	2'	Medium	3000K	16W	1600Lm
TECHOLED-BX-2P-D-2-HI-30	2'	High	3000K	20W	2000Lm
TECHOLED-BX-2P-D-4-LO-30	4'	Low	3000K	22W	2200Lm
TECHOLED-BX-2P-D-4-ME-30	4'	Medium	3000K	31W	3100Lm
TECHOLED-BX-2P-D-4-HI-30	4'	High	3000K	40W	4000Lm
TECHOLED-BX-2P-D-6-LO-30	6'	Low	3000K	33W	3300Lm
TECHOLED-BX-2P-D-6-ME-30	6'	Medium	3000K	46W	4600Lm
TECHOLED-BX-2P-D-6-HI-30	6'	High	3000K	60W	6000Lm
TECHOLED-BX-2P-D-8-LO-30	8'	Low	3000K	46W	4600Lm
TECHOLED-BX-2P-D-8-ME-30	8'	Medium	3000K	61W	6100Lm
TECHOLED-BX-2P-D-8-HI-30	8'	High	3000K	80W	8000Lm

Performance above applies to 90 CRI, 3000K. Calculate 96% for 2700K, 104% for 3500K and 109% for 4000K

Performance

Output Direct	Direct	
	Lumens / W	Lumens / ft
Low	100	550
Medium	100	770
High	100	1000

Project:	Type:
	Comments:

Driver Option Details

Code	Description
LT1	LDE1 - Lutron Hi-lume 1% EcoSystem, Soft-on, Fade-to Black Dimming
DA	DALI
DMX	DMX - Decoder provided by TechoLED, controller by others

Controls Details

Code	Description
RF-D	RF Wireless remote controller for tunable white. Default for tunable white.
RF-R	RF Wireless remote controller for RGB & RGBW. Default for RGB & RGBW.
M	Motion Sensor - remote, for integral sensor consult factory
BM	Bluetooth Mesh Smart Wireless Control by BubblyNet
CS	Bluetooth Mesh Smart Wireless Control by Casambi
AWNRR	Lutron Athena wireless node
AWNS	Lutron Athena wireless node with sensor
NL-ES7	Acuity nLight - Wired nES7 sensor
NL-AIR	Acuity nLight - AIR wireless rES7 sensor
NL-M	Acuity nLight - ready, sensor by others

Project:	Type:
	Comments:

□ Perimeter to T- grid

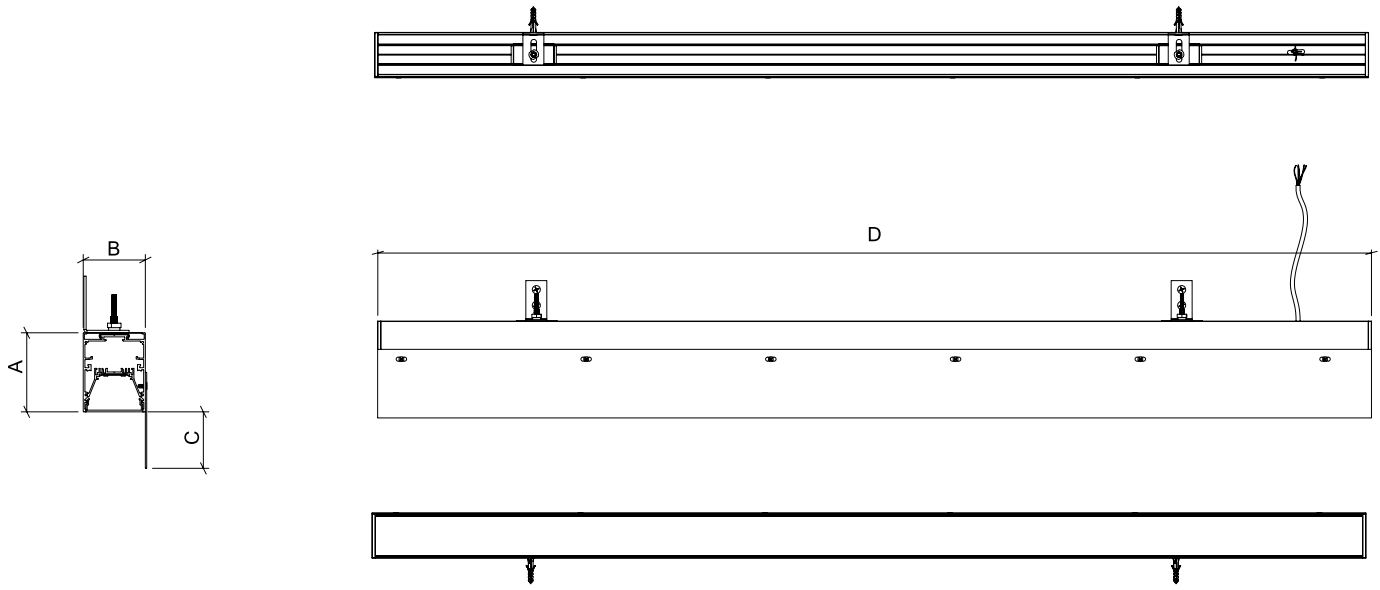

FIXTURE ID	A	B	C	D
BX-2P-D-2	2.76"	2.17"	2"	24"
BX-2P-D-4	2.76"	2.17"	2"	48"
BX-2P-D-6	2.76"	2.17"	2"	72"
BX-2P-D-8	2.76"	2.17"	2"	96"

Project:	Type:
	Comments:

■ Perimeter to T- grid

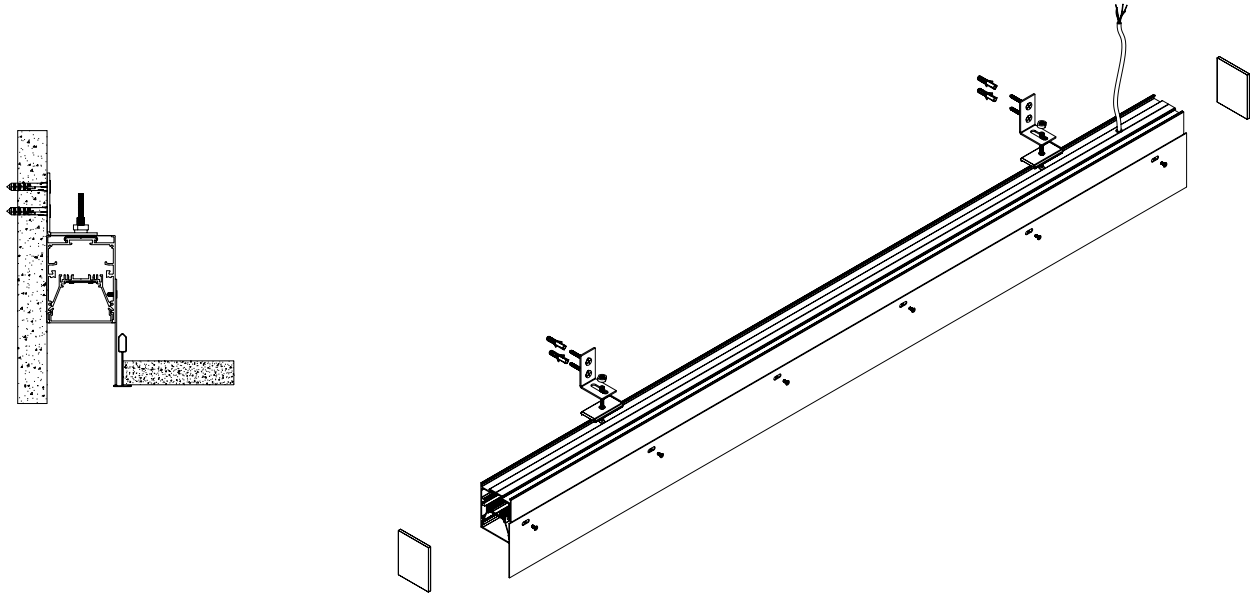

Perimeter to T- grid Kit

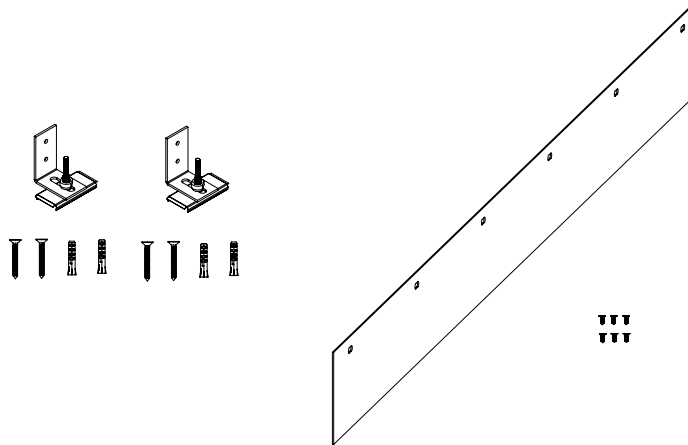

Project:	Type:
	Comments:

Connectors

BX-2P L-shape

BX-2P-L	Connector
A	25.08"
B	25.08"
C	2.76"
D	2.17"

Not to scale

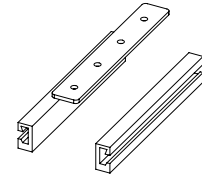
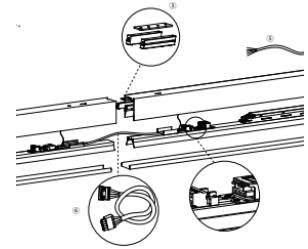
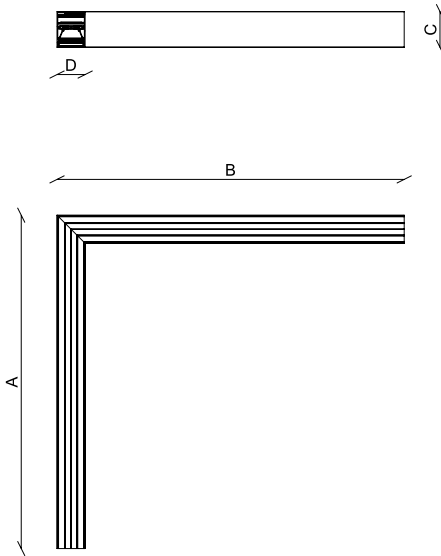
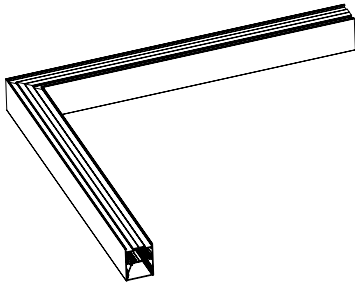

L45-180

Project:	Type:
	Comments:

Photometrics

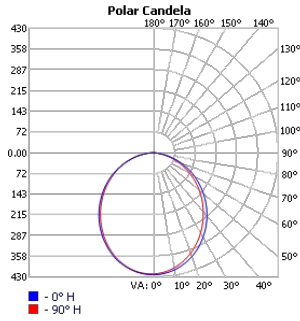

TECHOLED-BX-2P-D-2-LO-30

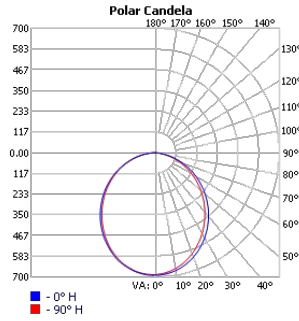

TECHOLED-BX-2P-D-2-ME-30

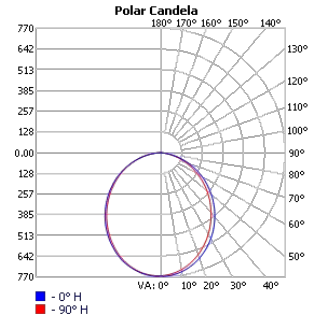

TECHOLED-BX-2P-D-2-HI-30

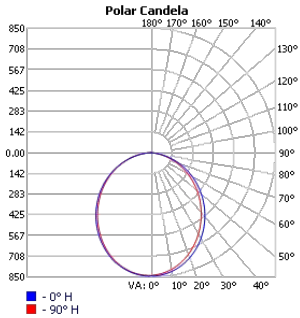

TECHOLED-BX-2P-D-4-LO-30

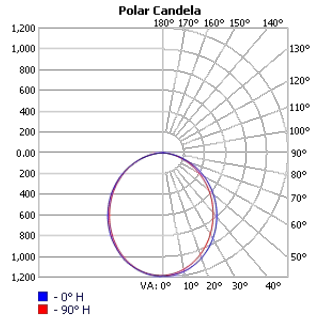

TECHOLED-BX-2P-D-4-ME-30

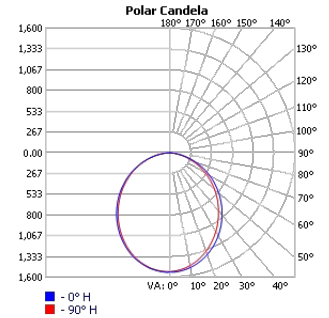

TECHOLED-BX-2P-D-4-HI-30

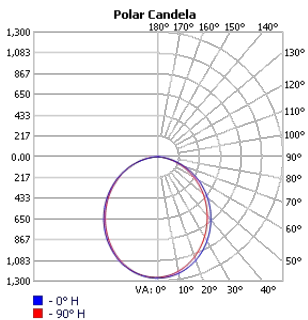

TECHOLED-BX-2P-D-6-LO-30

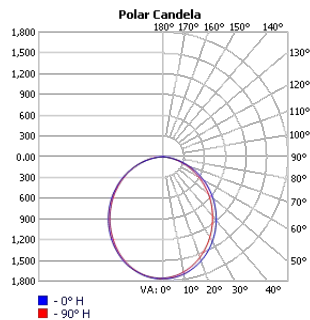

TECHOLED-BX-2P-D-6-ME-30

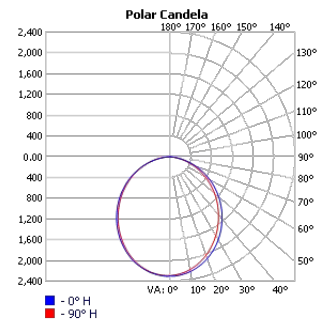

TECHOLED-BX-2P-D-6-HI-30

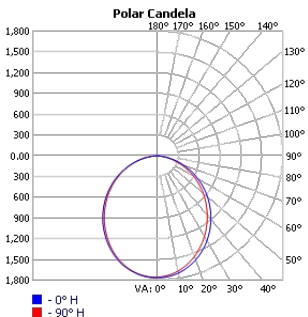

TECHOLED-BX-2P-D-8-LO-30

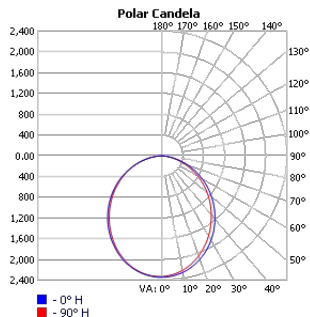

TECHOLED-BX-2P-D-8-ME-30

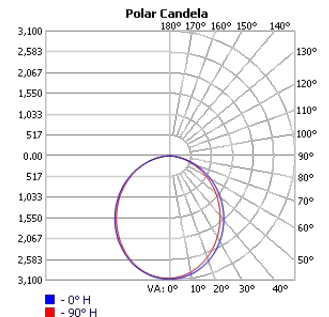

TECHOLED-BX-2P-D-8-HI-30

Project:	Type:
	Comments:

Patterns Option Examples

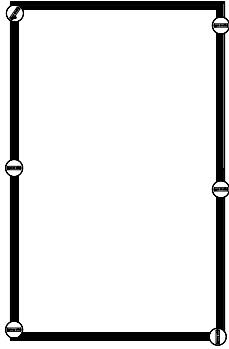

Rectangle

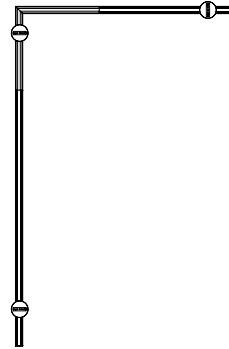

L-Shape

Project:	Type:
	Comments:

Finish Details (powder coat finish)

■ Standard Colors



■ Custom Colors

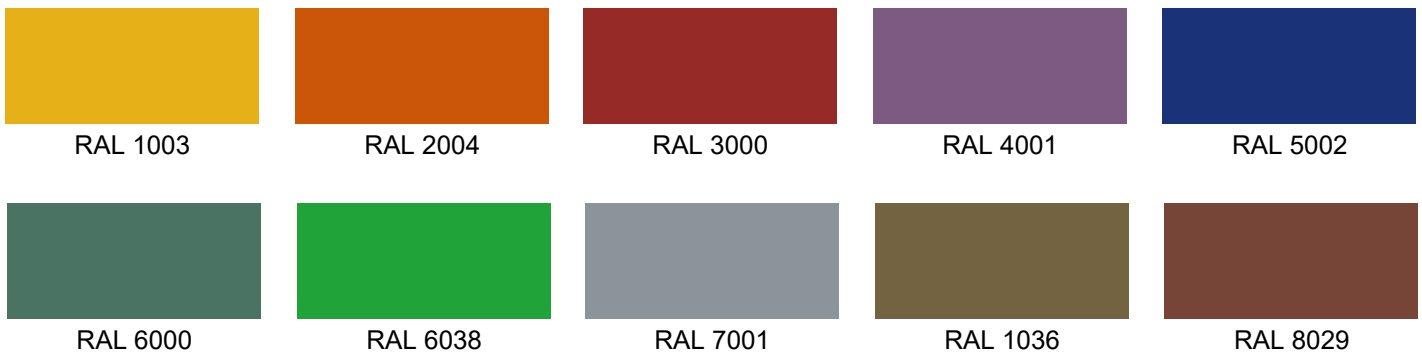

Any RAL color available, please refer to ralcolorchart.com

■ Custom Wooden Colors

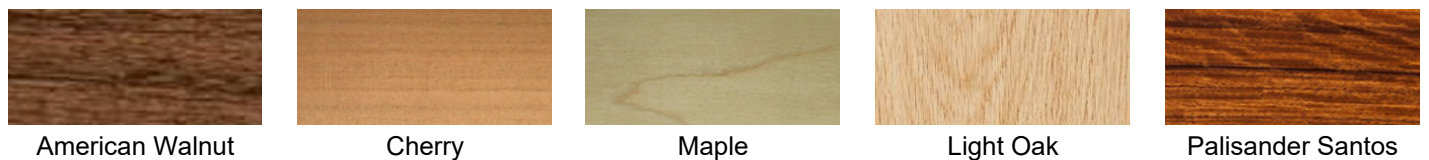

Project:	Type:
	Comments:

Color Temperature

Color Temperature

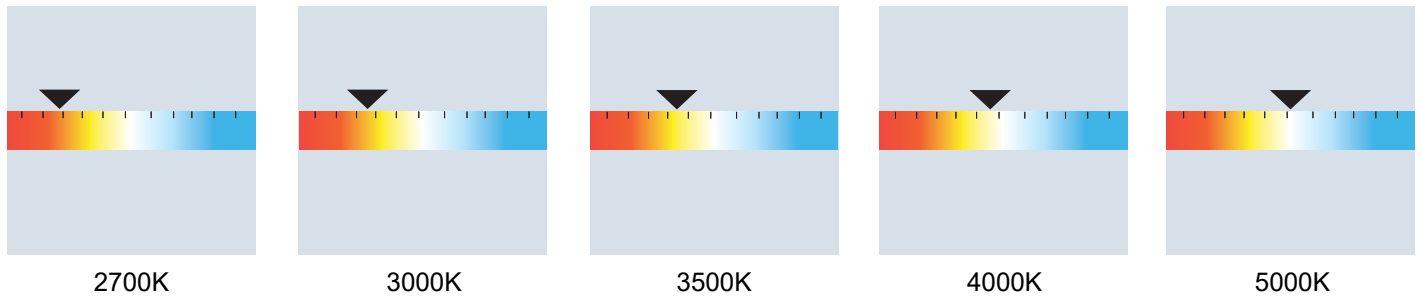

Tunable White

