

Project:	Type:
	Comments:



Highlights

The TechoLED BX series features specification-grade linear LED fixtures made from high-grade aluminum extrusions. Available in standard sizes from 2 to 8 feet, as well as custom lengths, recessed installation in variety of ceiling and materials. With virtually limitless options for creating patterns and shapes, the BX series provides a versatile, cost-effective, and modern lighting solution.

LED: Samsung LED chips, 2700-5000K, tunable white and RGB/RGBW available, 90CRI, 50,000 hour rated lifespan. Custom lumen packages available.

Optical: Direct illumination, multiple beam angles available (110° beam angle on solid lens), UGR<19

Construction: Damp location listed, high grade aluminum extrusion, die cast end caps, PMMA diffuser, powder coat finish. X, T, L lit corners, wall to ceiling transitions, for smooth seamless patterns.

Cross Section

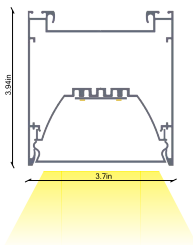

Installation

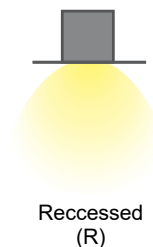

Project:	Type:
	Comments:

Configuration Example

Model #	Distribution	Length	Lumen Output	Color Temp.	Voltage	Color
TECHOLED-BX-4-R-D-4-LO-27-U-W	Direct	4'	Low	2700K	110-270V	White

Ordering Guide:

Select one option from each group below. For a custom preference please contact sales@techoled.com

1-FIXTURE ID	2-DISTRIBUTION	3-LENGTH	4-LUMEN OUTPUT
BX-4-R BX-4-R	D Direct	2 2'	LO Low
	DWW Direct, Wall Wash	4 4'	ME Medium
	BW Bat Wing	6 6'	HI High
		8 8'	
		C Custom	

5-COLOR TEMP.	6-VOLTAGE	7-FINISH	8-MOUNTING
27 2700K	U 110-277V	S Silver	RP Recessed (mud-in)
30 3000K	HV 347V	W White	TG T Grid Universal
35 3500K		B Black	
40 4000K		C Custom (RAL#)	
50 5000K			
DT Lutron T-series			
RGB RGB			
RGBW RGBW			
D Tunable White			

9-DRIVER OPTIONS	10-OPTIONS	11-OPTIONS (CONT.)
DM 0-10V Dimming	RF-D Remote Tunable (RF only)	EM EM Battery (remote)
2C 2 Channel	RF-R Remote RGB/W (RF only)	X None
DM1% 1% Dimming	M Motion Sensor (remote)	
LT1 LDE1 Lutron 1%	BM BubblyNet BT Mesh	
DA Dali	CS Casambi	
DMX DMX	AWN Lutron Athena Node	
TR Triac Dimming	AWNS Lutron Athena Node sensor	
RF RF Wireless	NL-ES7 nLight - Wired	
X None	NL-AIR nLight - AIR	
	NL-M nLight - Module only	
	X None	

Project:	Type:
	Comments:

Lumen Output Details

Model #	Size	Output	Color Temp.	Wattage	Lumen Output
TECHOLED-BX-4-R-D-2-LO-30	2'	Low	3000K	12W	1160Lm
TECHOLED-BX-4-R-D-2-ME-30	2'	Medium	3000K	18W	1800Lm
TECHOLED-BX-4-R-D-2-HI-30	2'	High	3000K	23W	2300Lm
TECHOLED-BX-4-R-D-4-LO-30	4'	Low	3000K	23W	2320Lm
TECHOLED-BX-4-R-D-4-ME-30	4'	Medium	3000K	36W	3600Lm
TECHOLED-BX-4-R-D-4-HI-30	4'	High	3000K	46W	4600Lm
TECHOLED-BX-4-R-D-6-LO-30	6'	Low	3000K	35W	3480Lm
TECHOLED-BX-4-R-D-6-ME-30	6'	Medium	3000K	54W	5400Lm
TECHOLED-BX-4-R-D-6-HI-30	6'	High	3000K	69W	6900Lm
TECHOLED-BX-4-R-D-8-LO-30	8'	Low	3000K	46W	4640Lm
TECHOLED-BX-4-R-D-8-ME-30	8'	Medium	3000K	72W	7200Lm
TECHOLED-BX-4-R-D-8-HI-30	8'	High	3000K	92W	9200Lm

Performance above applies to 90 CRI, 3000K. Calculate 96% for 2700K, 104% for 3500K and 109% for 4000K

Performance

Output	Lumens / W	Direct	
		W / ft	Lumens / ft
Low	100	5.8	580
Medium	100	9.0	900
High	100	11.5	1150

Project:	Type:
	Comments:

Driver Option Details

Code	Description
LT1	LDE1 - Lutron Hi-lume 1% EcoSystem, Soft-on, Fade-to Black Dimming
DA	DALI
DMX	DMX - Decoder provided by TechoLED, controller by others

Controls Details

Code	Description
RF-D	RF Wireless remote controller for tunable white. Default for tunable white.
RF-R	RF Wireless remote controller for RGB & RGBW. Default for RGB & RGBW.
M	Motion Sensor - remote, for integral sensor consult factory
BM	Bluetooth Mesh Smart Wireless Control by BubblyNet
CS	Bluetooth Mesh Smart Wireless Control by Casambi
AWNRR	Lutron Athena wireless node
AWNS	Lutron Athena wireless node with sensor
NL-ES7	Acuity nLight - Wired nES7 sensor
NL-AIR	Acuity nLight - AIR wireless rES7 sensor
NL-M	Acuity nLight - ready, sensor by others

Project:	Type:
	Comments:

Dimension and Mounting - Direct Distribution (D)

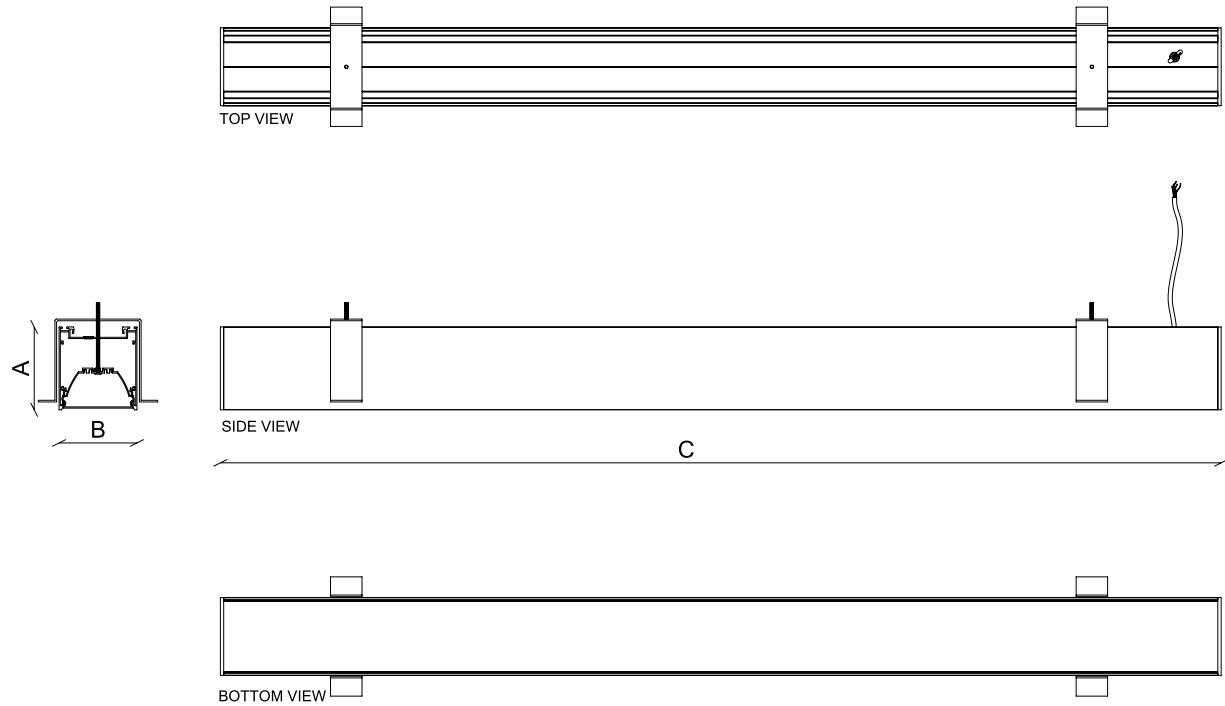

FIXTURE ID	A	B	C
BX-4-R-D-2	3.9"	3.7"	24.2"
BX-4-R-D-4	3.9"	3.7"	48"
BX-4-R-D-6	3.9"	3.7"	71.8"
BX-4-R-D-8	3.9"	3.7"	95.5"

Project:	Type:
	Comments:

■ **Recessed - T Grid 9/16" (universal bracket)**

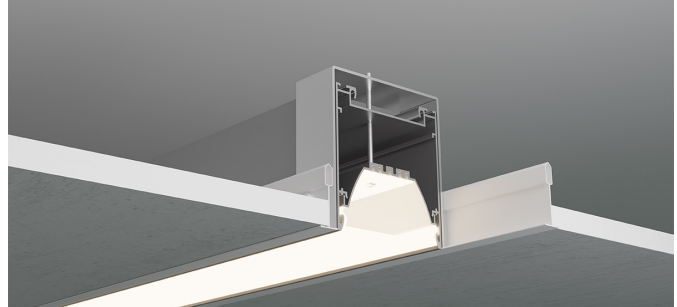
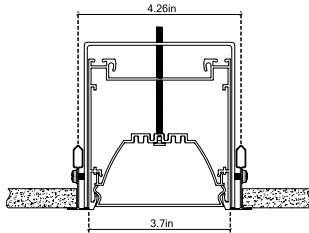

■ **Recessed - T Grid 15/16" (universal bracket)**

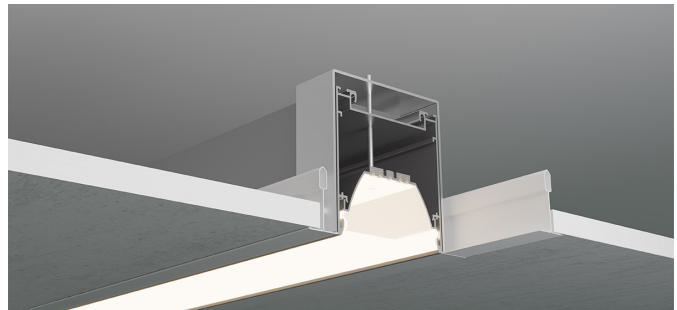
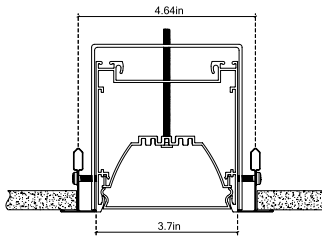

■ **Recessed - Slot Grid (universal bracket)**

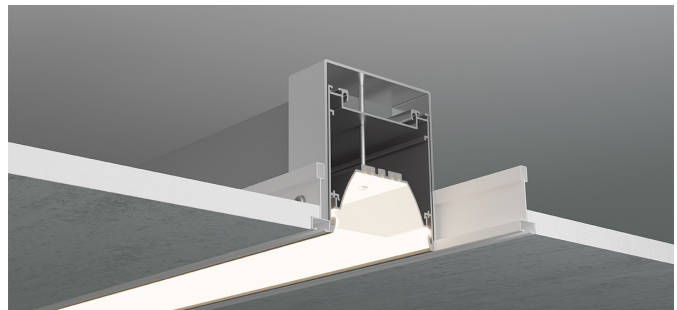
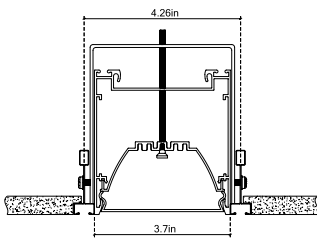

■ **Recessed - Tegular Grid 9/16" (universal bracket)**

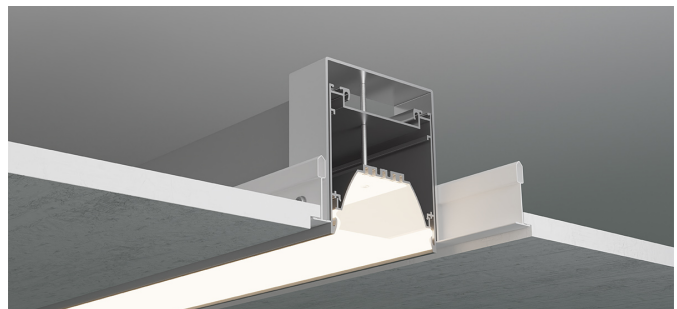
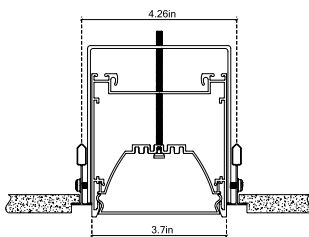

Project:	Type:
	Comments:

■ Recessed - Tegular Grid 15/16" (universal bracket)

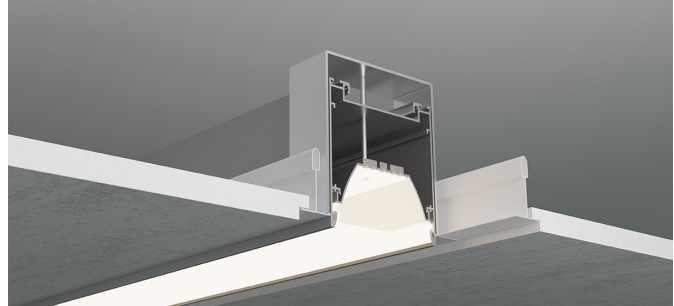
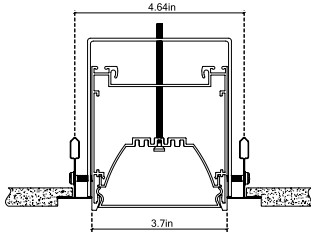

□ Connectors

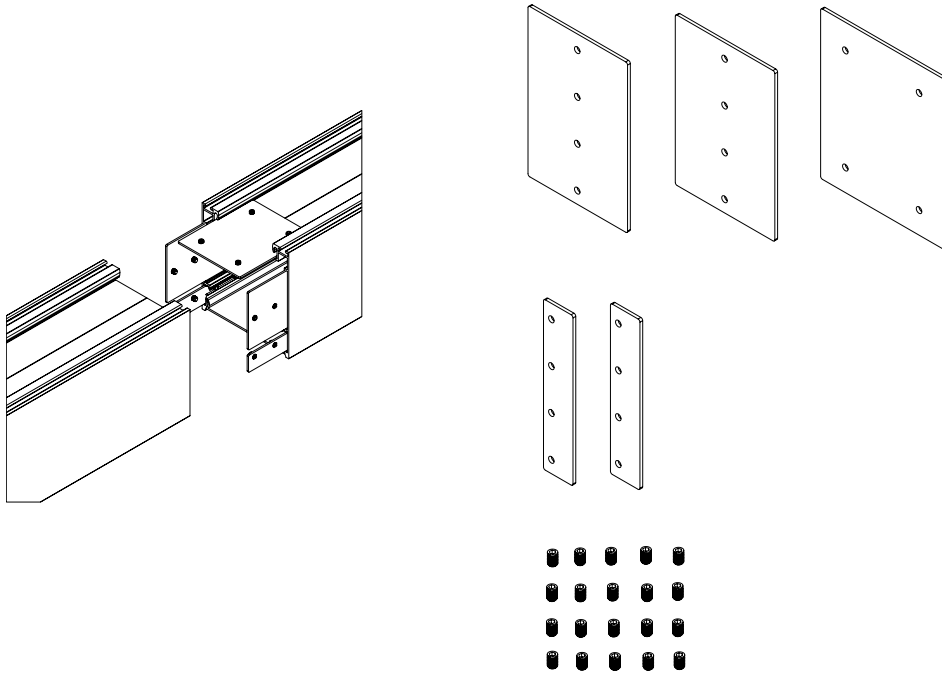

Project:	Type:
	Comments:

Photometrics

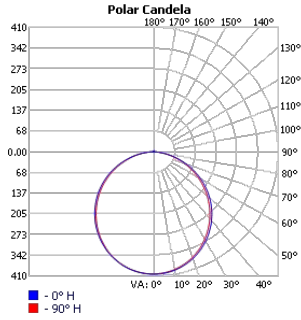

TECHOLED-BX-4-R-D-2-LO-30

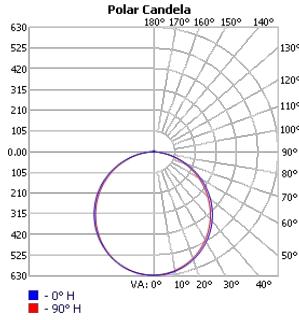

TECHOLED-BX-4-R-D-2-ME-30

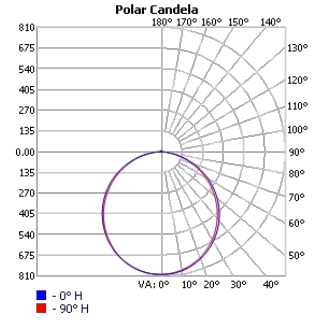

TECHOLED-BX-4-R-D-2-HI-30

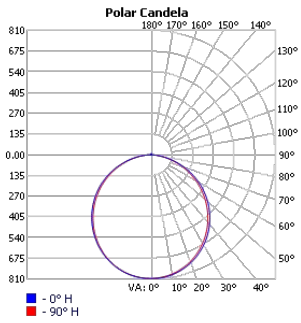

TECHOLED-BX-4-R-D-4-LO-30

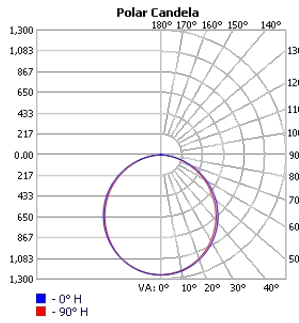

TECHOLED-BX-4-R-D-4-ME-30

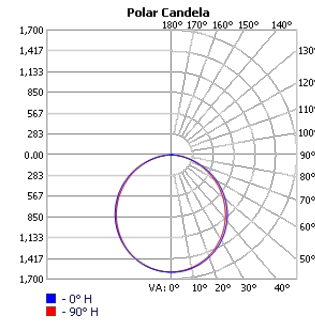

TECHOLED-BX-4-R-D-4-HI-30

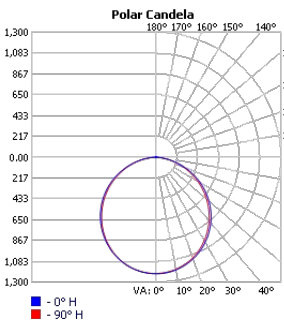

TECHOLED-BX-4-R-D-6-LO-30

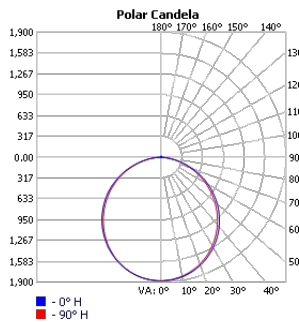

TECHOLED-BX-4-R-D-6-ME-30

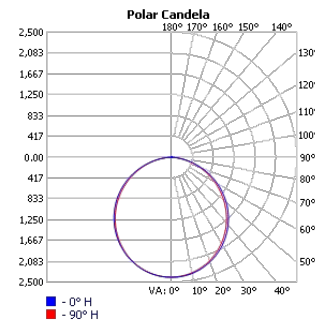

TECHOLED-BX-4-R-D-6-HI-30

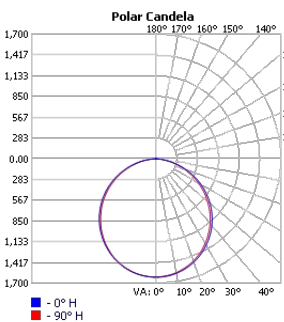

TECHOLED-BX-4-R-D-8-LO-30

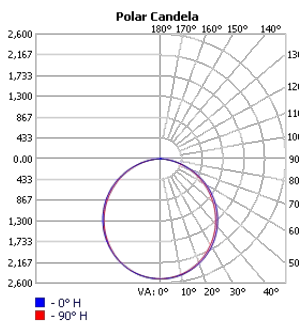

TECHOLED-BX-4-R-D-8-ME-30

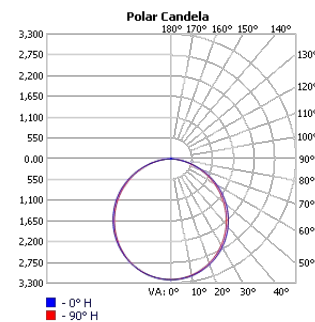

TECHOLED-BX-4-R-D-8-HI-30

Project:	Type:
	Comments:

Patterns Option Examples

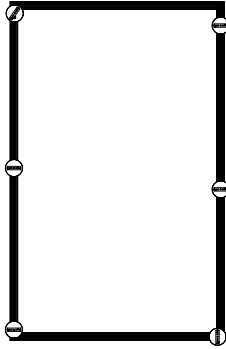

Rectangle

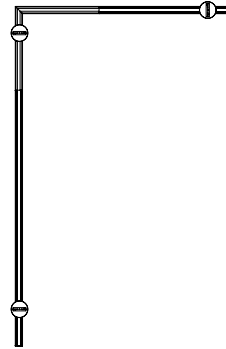

L-Shape

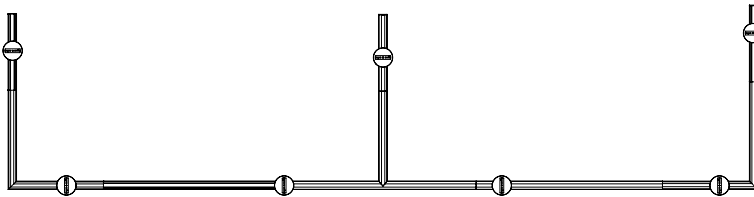

Custom

Project:	Type:
	Comments:

Finish Details (powder coat finish)

■ Standard Colors

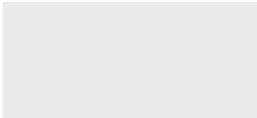

W – White



S – Silver



B – Black

■ Custom Colors



RAL 1003



RAL 2004



RAL 3000



RAL 4001



RAL 5002



RAL 6000



RAL 6038



RAL 7001



RAL 1036



RAL 8029

Any RAL color available, please refer to ralcolorchart.com

■ Custom Wooden Colors



American Walnut

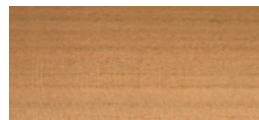

Cherry

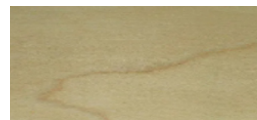

Maple



Light Oak



Palisander Santos

Project:	Type:
	Comments:

Color Temperature

Color Temperature

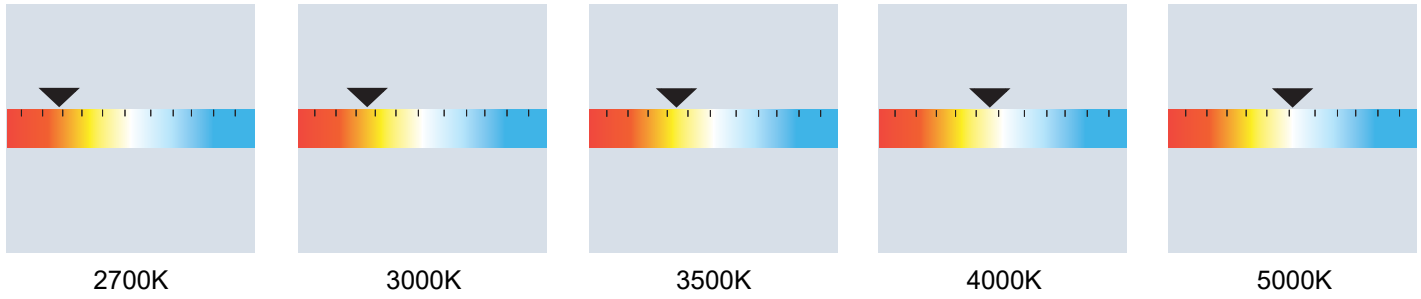

Tunable White

