



Highlights

The TechoLED BX series features specification-grade linear LED fixtures made from high-grade aluminum extrusions. Available in standard sizes from 2 to 8 feet, as well as custom lengths, these fixtures can be pendant, surface, or wall-mounted. With virtually limitless options for creating patterns and shapes, the BX series provides a versatile, cost-effective, and modern lighting solution.

LED: Samsung LED chips, 2700-5000K, tunable white and RGB/RGBW available, 90CRI, 50,000 hour rated lifespan. Custom lumen packages available.

Optical: Direct and direct/indirect illumination, 110° beam angle, UGR<19

Construction: Damp location listed, high grade aluminum extrusion, die cast end caps, PMMA diffuser, powder coat finish. X, T, L lit corners, wall to ceiling transitions, for smooth seamless patterns.

Cross Section

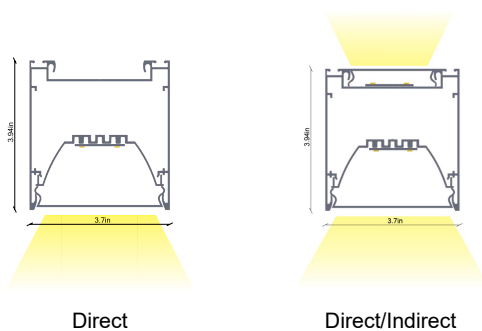

Installation

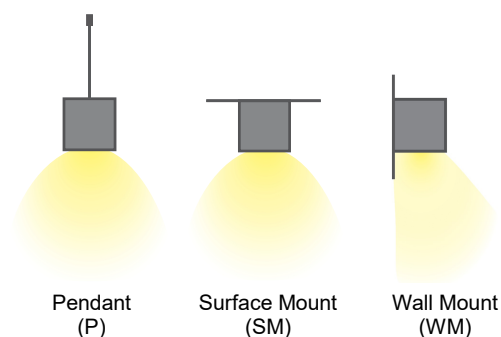

Configuration Example

Model #	Distribution	Length	Lumen Output	Color Temp.	Voltage	Color
TECHOLED-BX-4-D-4-LO-27-U-W	Direct/Indirect	4'	Low	2700K	110-277V	White

Ordering Guide:

Select one option from each group below. For a custom preference please contact sales@techoled.com

1-FIXTURE ID		2-DISTRIBUTION		3-LENGTH		4-LUMEN OUTPUT	
BX-4	BX-4	D	Direct	2	2'	LO	Low
		DI	Direct/Indirect	4	4'	ME	Medium
		DI2	D/I2-circuit	6	6'	HI	High
		DWW	Direct, Wall Wash	8	8'		
		BW	Bat Wing	C	Custom		

5-COLOR TEMP.		6-VOLTAGE		7-FINISH		8-MOUNTING	
27	2700K	U	110-277V	S	Silver	P	Pendant
30	3000K	HV	347V	W	White	SM	Surface Mount
35	3500K			B	Black	W	Wall Mount
40	4000K			C	Custom (RAL#)		
50	5000K						
DT	Lutron T-series						
RGB	RGB						
RGBW	RGBW						
D	Tunable White						

9-DRIVER OPTIONS		10-OPTIONS		11-OPTIONS (CONT.)	
DM	0-10V Dimming	RF-D	Remote Tunable (RF only)	EM	EM Battery (remote)
2C	2 Channel	RF-R	Remote RGB/W (RF only)	X	None
DM1%	1% Dimming	M	Motion Sensor (remote)		
LT1	LDE1 Lutron 1%	BM	BubblyNet BT Mesh		
DA	Dali	CS	Casambi		
DMX	DMX	AWN	Lutron Athena Node		
TR	Triac Dimming	AWNS	Lutron Athena Node sensor		
RF	RF Wireless	NL-ES7	nLight - Wired		
X	None	NL-AIR	nLight - AIR		
		NL-M	nLight - Module only		
		X	None		

Lumen Output Details

Model #	Size	Output	Color Temp.	Wattage	Lumen Output
TECHOLED-BX-4-D-2-LO-30	2'	Low	3000K	12W	1160Lm
TECHOLED-BX-4-D-2-ME-30	2'	Medium	3000K	18W	1800Lm
TECHOLED-BX-4-D-2-HI-30	2'	High	3000K	23W	2300Lm
TECHOLED-BX-4-D-4-LO-30	4'	Low	3000K	23W	2320Lm
TECHOLED-BX-4-D-4-ME-30	4'	Medium	3000K	36W	3600Lm
TECHOLED-BX-4-D-4-HI-30	4'	High	3000K	46W	4600Lm
TECHOLED-BX-4-D-6-LO-30	6'	Low	3000K	35W	3480Lm
TECHOLED-BX-4-D-6-ME-30	6'	Medium	3000K	54W	5400Lm
TECHOLED-BX-4-D-6-HI-30	6'	High	3000K	69W	6900Lm
TECHOLED-BX-4-D-8-LO-30	8'	Low	3000K	46W	4640Lm
TECHOLED-BX-4-D-8-ME-30	8'	Medium	3000K	72W	7200Lm
TECHOLED-BX-4-D-8-HI-30	8'	High	3000K	92W	9200Lm

Performance above applies to 90 CRI, 3000K. Calculate 96% for 2700K, 104% for 3500K and 109% for 4000K

Model #	Size	Output	Color Temp.	Wattage	Down Lumen Out.	Up Lumen Out.
TECHOLED-BX-4-DI-2-LO-30	2'	Low	3000K	17W	1160Lm	570Lm
TECHOLED-BX-4-DI-2-ME-30	2'	Medium	3000K	23W	1800Lm	900Lm
TECHOLED-BX-4-DI-2-HI-30	2'	High	3000K	30W	2300Lm	1150Lm
TECHOLED-BX-4-DI-4-LO-30	4'	Low	3000K	34W	2320Lm	1160Lm
TECHOLED-BX-4-DI-4-ME-30	4'	Medium	3000K	46W	3600Lm	1800Lm
TECHOLED-BX-4-DI-4-HI-30	4'	High	3000K	60W	4600Lm	2300Lm
TECHOLED-BX-4-DI-6-LO-30	6'	Low	3000K	51W	3480Lm	1740Lm
TECHOLED-BX-4-DI-6-ME-30	6'	Medium	3000K	68W	5400Lm	2700Lm
TECHOLED-BX-4-DI-6-HI-30	6'	High	3000K	90W	6900Lm	3450Lm
TECHOLED-BX-4-DI-8-LO-30	8'	Low	3000K	68W	4640Lm	2320Lm
TECHOLED-BX-4-DI-8-ME-30	8'	Medium	3000K	91W	7200Lm	3600Lm
TECHOLED-BX-4-DI-8-HI-30	8'	High	3000K	120W	9200Lm	4600Lm

Performance above applies to 90 CRI, 3000K. Calculate 96% for 2700K, 104% for 3500K and 109% for 4000K

Performance

Output	Direct			Indirect		
	Lumens / W	W / ft	Lumens / ft	Lumens / W	W / ft	Lumens / ft
Low	100	5.8	580	100	2.9	290
Medium	100	9.0	900	100	4.5	450
High	100	11.5	1150	100	5.8	575

Driver Option Details

Code	Description
LT1	LDE1 -Lutron Hi-lume 1% EcoSystem, Soft-on, Fade-to Black Dimming
DA	DALI
DMX	DMX - Decoder provided by TechoLED, controller by others

Controls Details

Code	Description
RF-D	RF Wireless remote controller for tunable white. Default for tunable white.
RF-R	RF Wireless remote controller for RGB & RGBW. Default for RGB & RGBW.
M	Motion Sensor - remote, for integral sensor consult factory
BM	Bluetooth Mesh Smart Wireless Control by BubblyNet
CS	Bluetooth Mesh Smart Wireless Control by Casambi
AWN R	Lutron Athena wireless node
AWN S	Lutron Athena wireless node with sensor
NL-ES7	Acuity nLight – Wired nES7 sensor
NL-AIR	Acuity nLight – AIR wireless rES7 sensor
NL-M	Acuity nLight - ready, sensor by others

Dimension and Mounting - Direct Distribution (D)

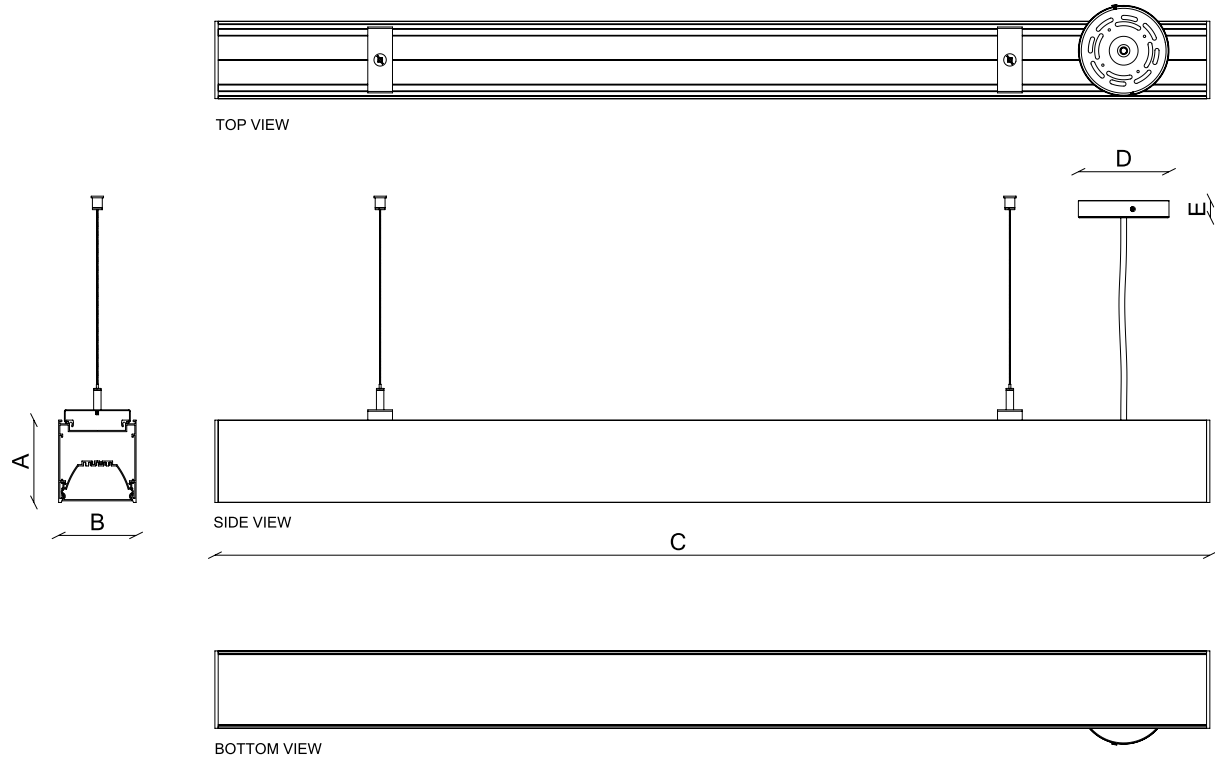

FIXTURE ID	A	B	C	D	E
BX-4-D-2	3.9"	3.7"	24.2"	4.33"	0.98"
BX-4-D-4	3.9"	3.7"	48"	4.33"	0.98"
BX-4-D-6	3.9"	3.7"	71.8"	4.33"	0.98"
BX-4-D-8	3.9"	3.7"	95.5"	4.33"	0.98"

■ Pendant Mount (D)

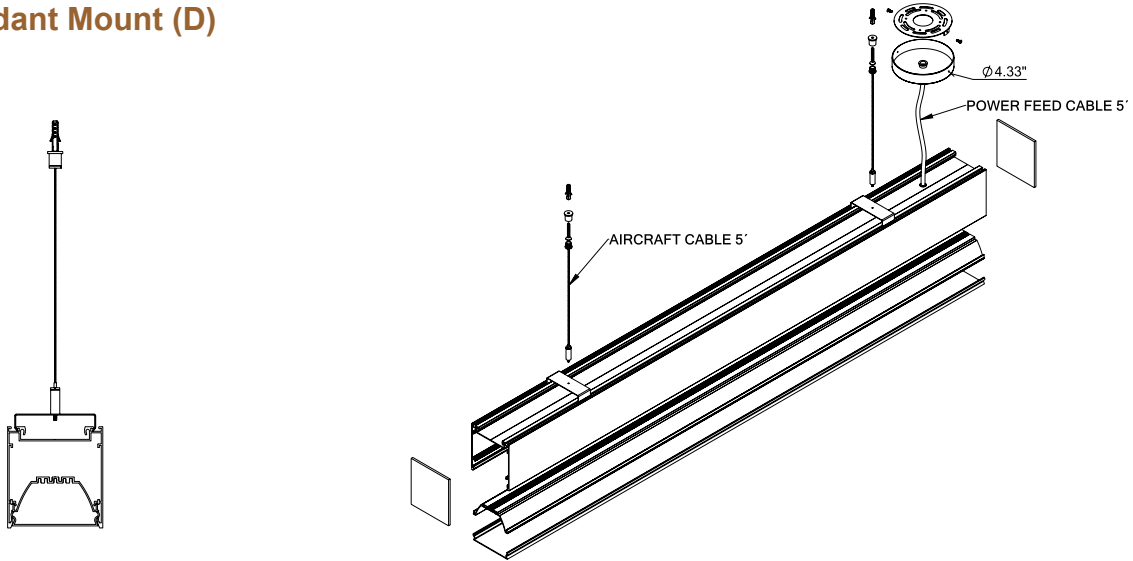

■ Pendant Kit

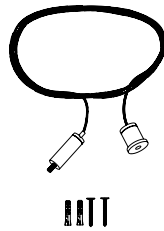

■ Surface Mount (D)

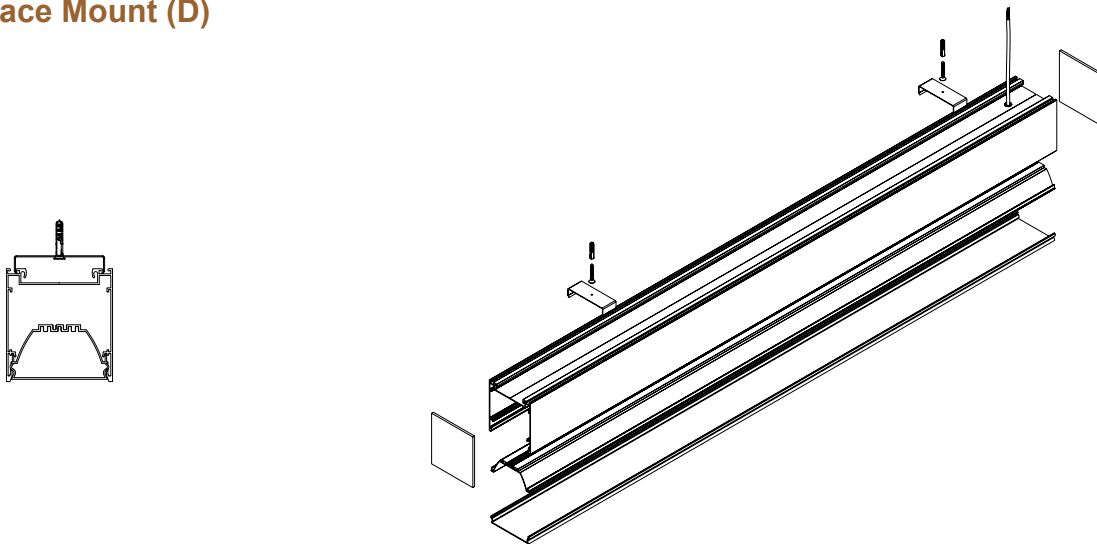

■ Surface Mount Kit

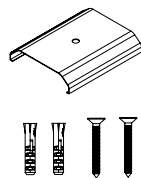

■ Wall Mount (D)

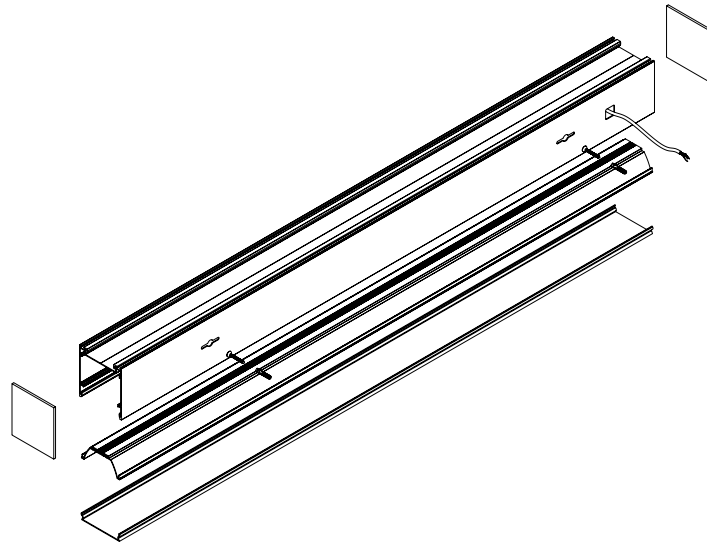
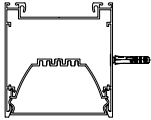

■ Wall Mount Kit

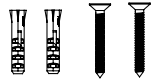

Dimension and Mounting - Direct/Indirect Distribution (DI)

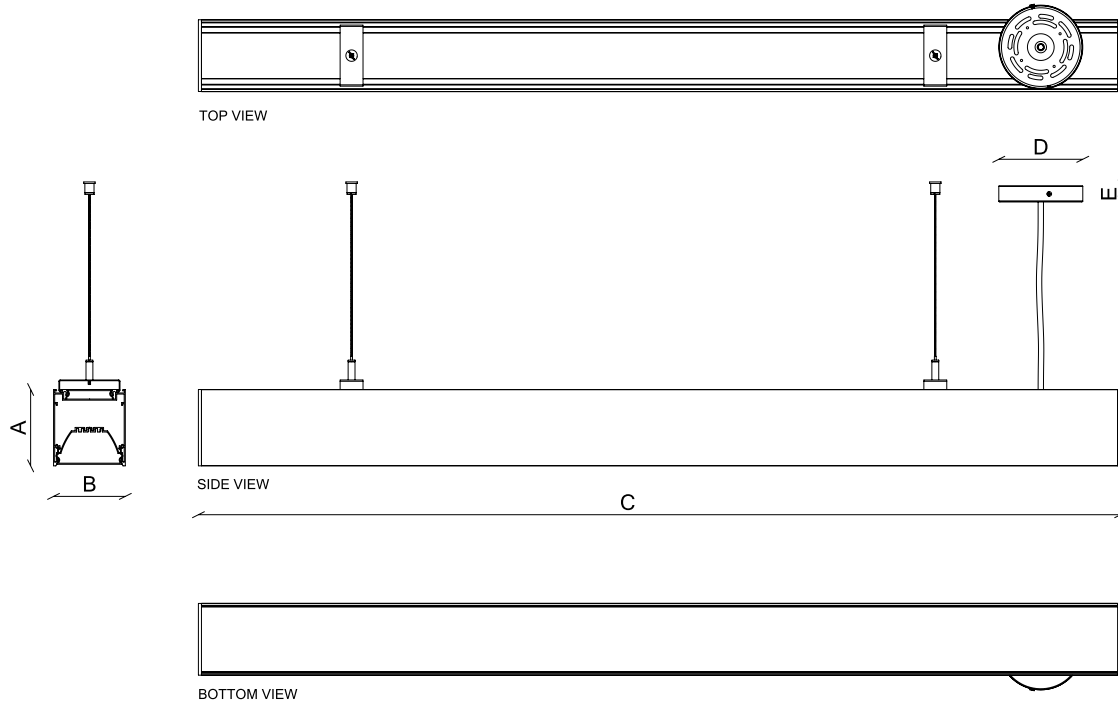

FIXTURE ID	A	B	C	D	E
BX-4-DI-2	3.9"	3.7"	24.2"	4.33"	0.98"
BX-4-DI-4	3.9"	3.7"	48"	4.33"	0.98"
BX-4-DI-6	3.9"	3.7"	71.8"	4.33"	0.98"
BX-4-DI-8	3.9"	3.7"	95.5"	4.33"	0.98"

■ Pendant Mount (DI)

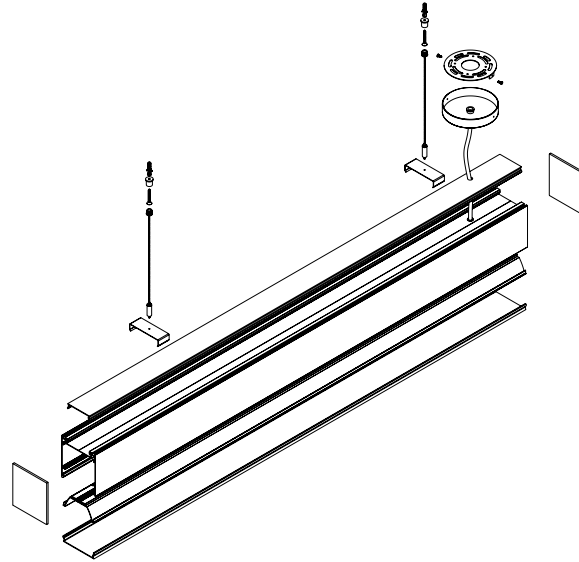
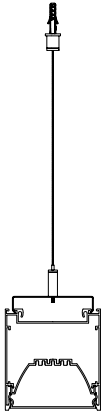

■ Pendant Kit

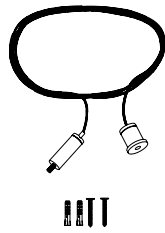

■ Wall Mount (DI)

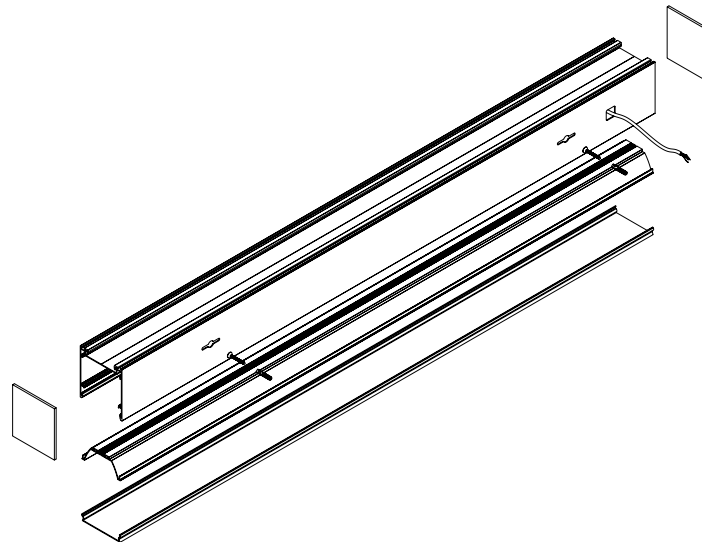
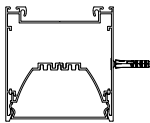

■ Wall Mount Kit

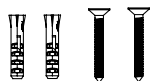

Connectors

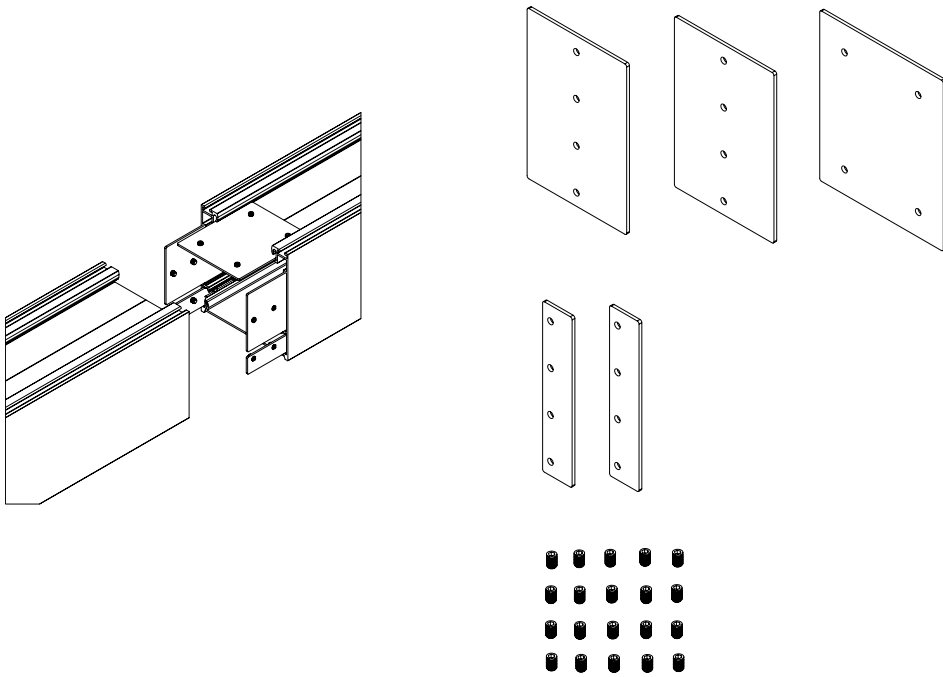

Photometrics

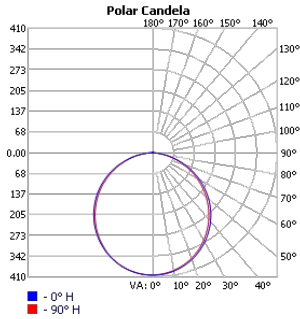

TECHOLED-BX-4-D-2-LO-30

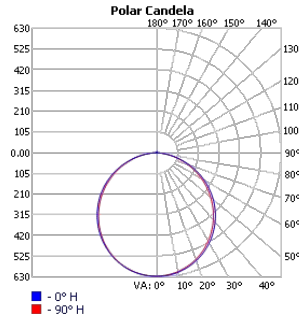

TECHOLED-BX-4-D-2-ME-30

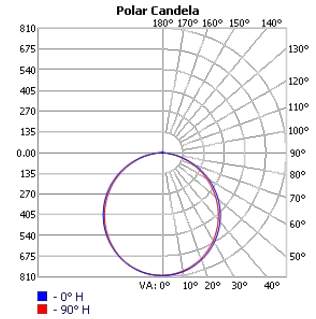

TECHOLED-BX-4-D-2-HI-30

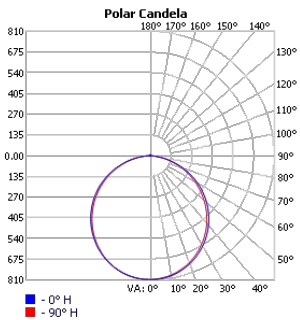

TECHOLED-BX-4-D-4-LO-30

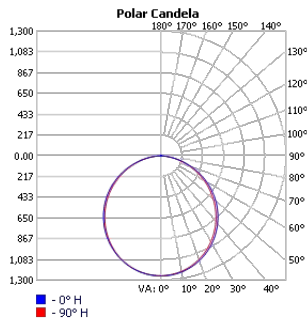

TECHOLED-BX-4-D-4-ME-30

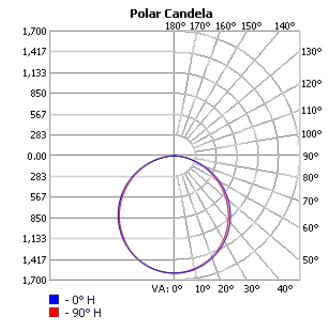

TECHOLED-BX-4-D-4-HI-30

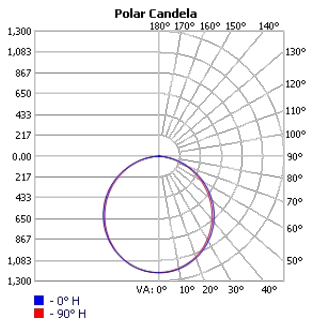

TECHOLED-BX-4-D-6-LO-30

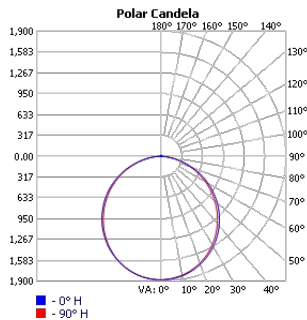

TECHOLED-BX-4-D-6-ME-30

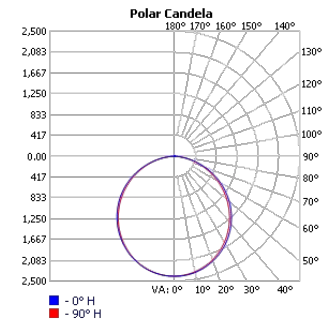

TECHOLED-BX-4-D-6-HI-30

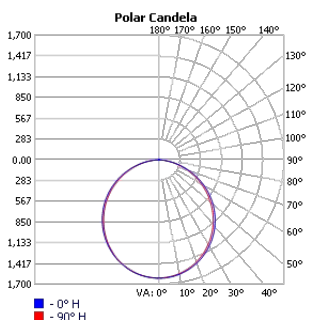

TECHOLED-BX-4-D-8-LO-30

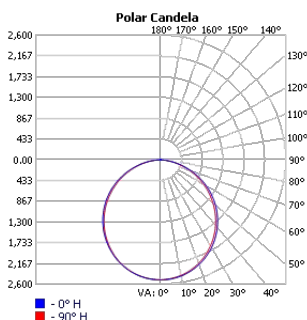

TECHOLED-BX-4-D-8-ME-30

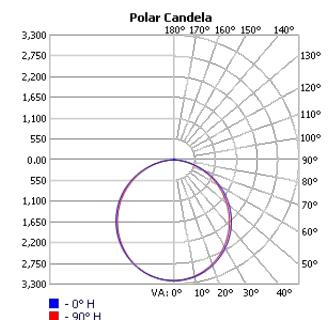

TECHOLED-BX-4-D-8-HI-30

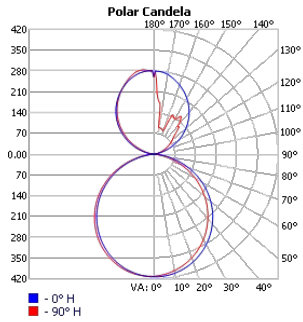

TECHOLED-BX-4-DI-2-LO-30

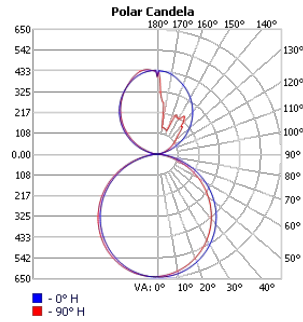

TECHOLED-BX-4-DI-2-ME-30

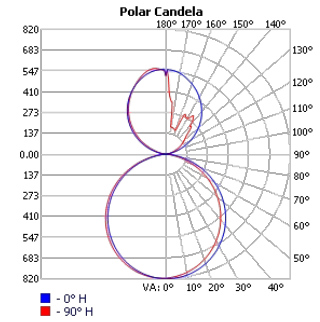

TECHOLED-BX-4-DI-2-HI-30

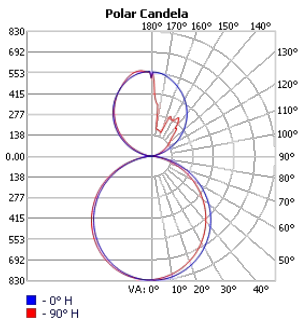

TECHOLED-BX-4-DI-4-LO-30

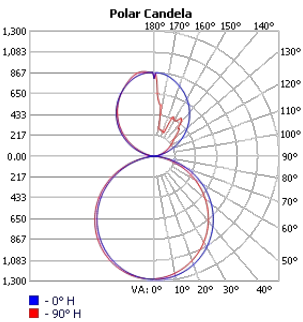

TECHOLED-BX-4-DI-4-ME-30

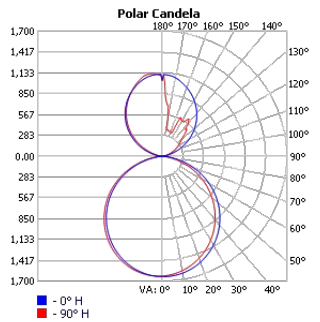

TECHOLED-BX-4-DI-4-HI-30

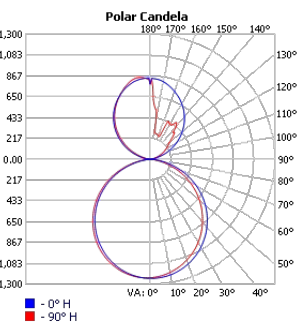

TECHOLED-BX-4-DI-6-LO-30

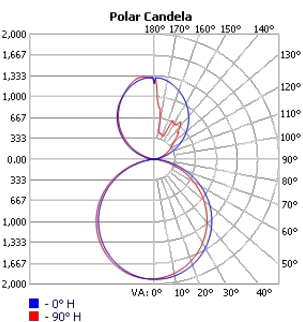

TECHOLED-BX-4-DI-6-ME-30

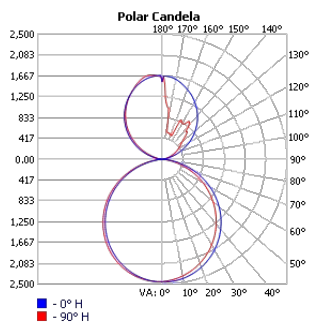

TECHOLED-BX-4-DI-6-HI-30

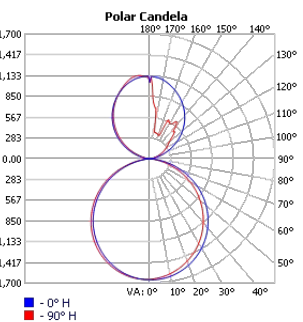

TECHOLED-BX-4-DI-8-LO-30

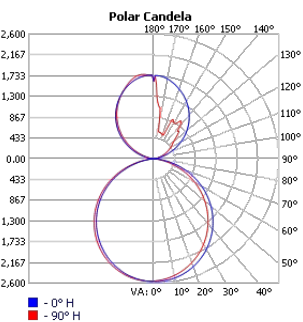

TECHOLED-BX-4-DI-8-ME-30

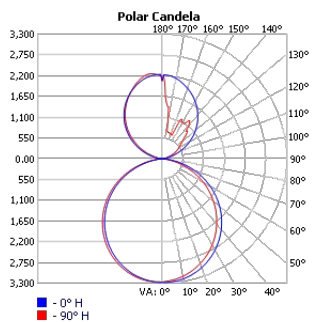

TECHOLED-BX-4-DI-8-HI-30

Patterns Option Examples

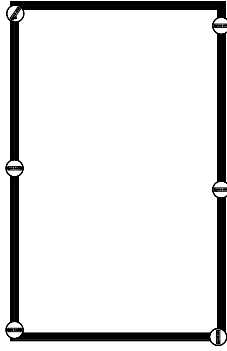

Rectangle

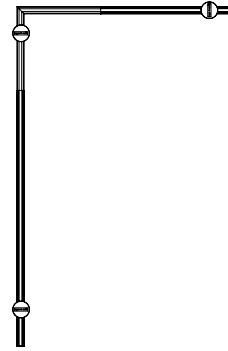

L-Shape

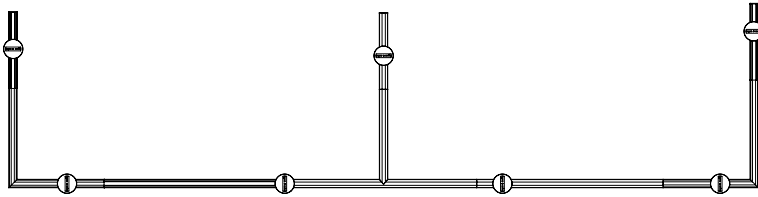

Custom

Finish Details (powder coat finish)

■ Standard Colors

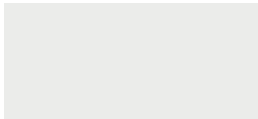

W – White



S – Silver



B – Black

■ Custom Colors



RAL 1003



RAL 2004



RAL 3000



RAL 4001



RAL 5002



RAL 6000



RAL 6038



RAL 7001



RAL 1036



RAL 8029

Any RAL color available, please refer to ralcolorchart.com

■ Custom Wooden Colors



American Walnut

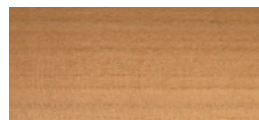

Cherry

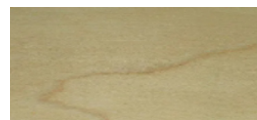

Maple



Light Oak



Palisander Santos

Color Temperature

Color Temperature

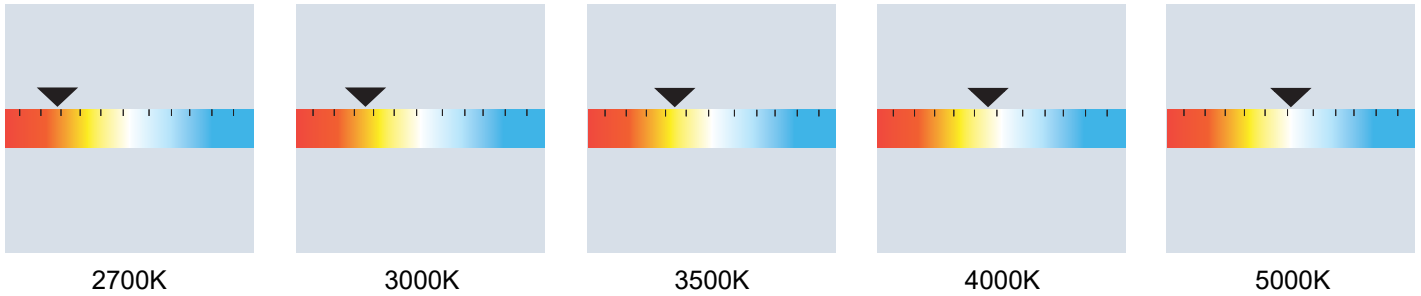

Tunable White

