

Project:	Type:
	Comments:



### Highlights

The TechoLED BX series features specification-grade linear LED fixtures made from high-grade aluminum extrusions. Available in standard sizes from 2 to 8 feet, as well as custom lengths, these fixtures can be pendant, surface, or wall-mounted. With virtually limitless options for creating patterns and shapes, the BX series provides a versatile, cost-effective, and modern lighting solution.

**LED:** Samsung LED chips, 2700-5000K, tunable white and RGB/RGBW available, 90CRI, 50,000 hour rated lifespan. Custom lumen packages available.

**Optical:** Direct and direct/indirect illumination, 110° beam angle, UGR<19

**Construction:** Damp location listed, high grade aluminum extrusion, die cast end caps, PMMA diffuser, powder coat finish. X, T, L lit corners, wall to ceiling transitions, for smooth seamless patterns.

### Cross Section

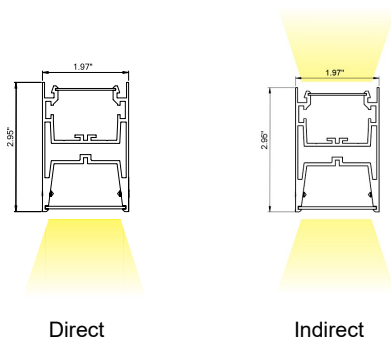

### Installation

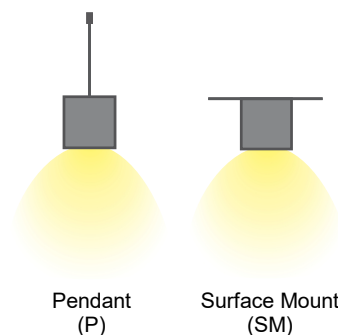

Project:	Type:
	Comments:

### Configuration Example

Model #	Distribution	Length	Lumen Output	Color Temp.	Voltage	Color
TECHOLED-BX-CURV-D-C-ME-27-U-W	Direct	Custom	Medium	2700K	110-277V	White

### Ordering Guide:

Select one option from each group below. For a custom preference please contact [sales@techoled.com](mailto:sales@techoled.com)

1-FIXTURE ID	2-DISTRIBUTION	3-LENGTH	4-LUMEN OUTPUT
<b>BX-CURV</b>	<b>D</b> Direct <b>DI</b> Direct/Indirect <b>DI2</b> D/I2-circuit	<b>C</b> Custom	<b>LO</b> Low <b>ME</b> Medium <b>HI</b> High

5-COLOR TEMP.	6-VOLTAGE	7-FINISH	8-MOUNTING
<b>27</b> 2700K <b>30</b> 3000K <b>35</b> 3500K <b>40</b> 4000K <b>50</b> 5000K <b>DT</b> Lutron T-series <b>RGB</b> RGB <b>RGBW</b> RGBW <b>D</b> Tunable White	<b>U</b> 110-277V <b>HV</b> 347V	<b>W</b> White <b>S</b> Silver <b>B</b> Black <b>C</b> Custom (RAL#)	<b>P</b> Pendant <b>SM</b> Surface Mount

9-DRIVER OPTIONS	10-OPTIONS	11-OPTIONS (CONT.)
<b>DM</b> 0-10V Dimming <b>2C</b> 2 Channel <b>DM1%</b> 1% Dimming <b>LT1</b> LDE1 Lutron 1% <b>DA</b> Dali <b>DMX</b> DMX <b>TR</b> Triac Dimming <b>RF</b> RF Wireless <b>X</b> None	<b>RF-D</b> Remote Tunable (RF only) <b>RF-R</b> Remote RGB/W (RF only) <b>M</b> Motion Sensor (remote) <b>BM</b> BubblyNet BT Mesh <b>CS</b> Casambi <b>AWN R</b> Lutron Athena Node <b>AWN S</b> Lutron Athena Node sensor <b>NL-ES7</b> nLight - Wired <b>NL-AIR</b> nLight - AIR <b>NL-M</b> nLight - Module only <b>X</b> None	<b>EM</b> EM Battery (remote) <b>X</b> None

Project:	Type:
	Comments:

### Lumen Output Details

#### Direct Distribution

Model #	Distribution	Length	Output	Color Temp.	Lumens / W	W / ft	Lumens / ft
TECHOLED-BX-CURV-D-C-LO-30	Direct	Custom	Low	3000K	100	6	600
TECHOLED-BX-CURV-D-C-ME-30	Direct	Custom	Medium	3000K	100	10	1000
TECHOLED-BX-CURV-D-C-HI-30	Direct	Custom	High	3000K	105	15	1500

#### Direct / Indirect Distribution

Model #	Distribution	Length	Output	Color Temp.	Lumens / W	W / ft	Direct/Indirect	
							Lumens / ft	Lumens / ft
TECHOLED-BX-CURV-DI-C-LO-30	Direct/Indirect	Custom	Low	3000K	100	9	600	300
TECHOLED-BX-CURV-DI-C-ME-30	Direct/Indirect	Custom	Medium	3000K	100	13	1000	300
TECHOLED-BX-CURV-DI-C-ME-30	Direct/Indirect	Custom	High	3000K	105/100	18	1500	300

Performance above applies to 90 CRI, 3000K. Calculate 96% for 2700K, 104% for 3500K and 109% for 4000K

Project:	Type:
	Comments:

### Driver Option Details

Code	Description
LT1	<b>LDE1</b> -Lutron Hi-lume 1% EcoSystem, Soft-on, Fade-to Black Dimming
DA	<b>DALI</b>
DMX	<b>DMX</b> - Decoder provided by TechoLED, controller by others

### Controls Details

Code	Description
RF-D	<b>RF Wireless</b> remote controller for tunable white. <b>Default for tunable white.</b>
RF-R	<b>RF Wireless</b> remote controller for RGB & RGBW. <b>Default for RGB &amp; RGBW.</b>
M	<b>Motion Sensor</b> - remote, for integral sensor consult factory
BM	<b>Bluetooth Mesh</b> Smart Wireless Control by BubblyNet
CS	<b>Bluetooth Mesh</b> Smart Wireless Control by Casambi
AWNDR	<b>Lutron Athena</b> wireless node
AWNS	<b>Lutron Athena</b> wireless node with sensor
NL-ES7	<b>Acuity nLight</b> – Wired nES7 sensor
NL-AIR	<b>Acuity nLight</b> – AIR wireless rES7 sensor
NL-M	<b>Acuity nLight</b> - ready, sensor by others

### Length Details

Code	Description
C	Custom, Drawing required (consult factory)

Project:	Type:
	Comments:

### Dimension and Mounting - Direct Distribution (D)

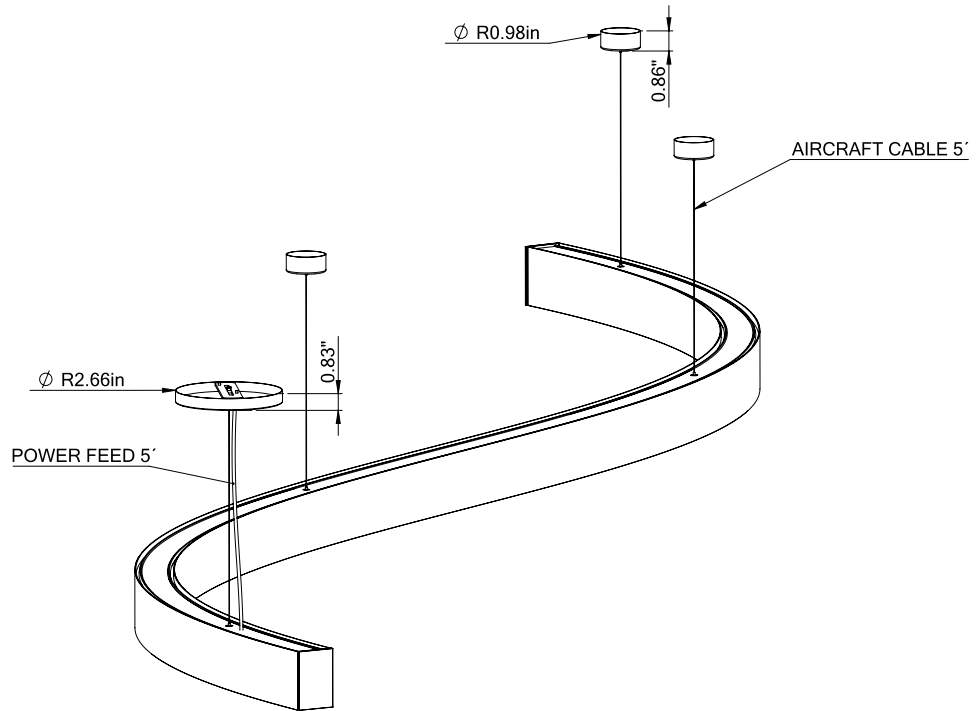
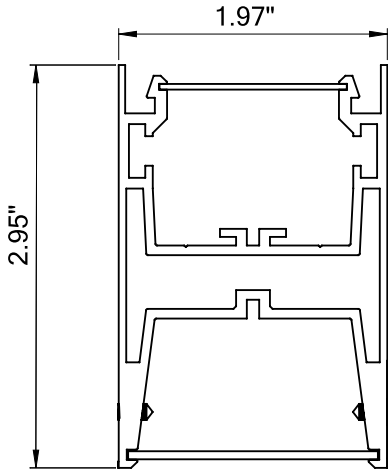

Project:	Type:
	Comments:

### ■ Pendant Mounting (D)

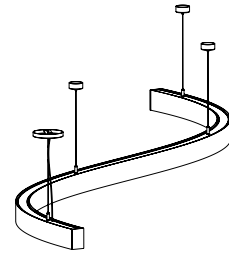

### ■ Surface Mounting (D)

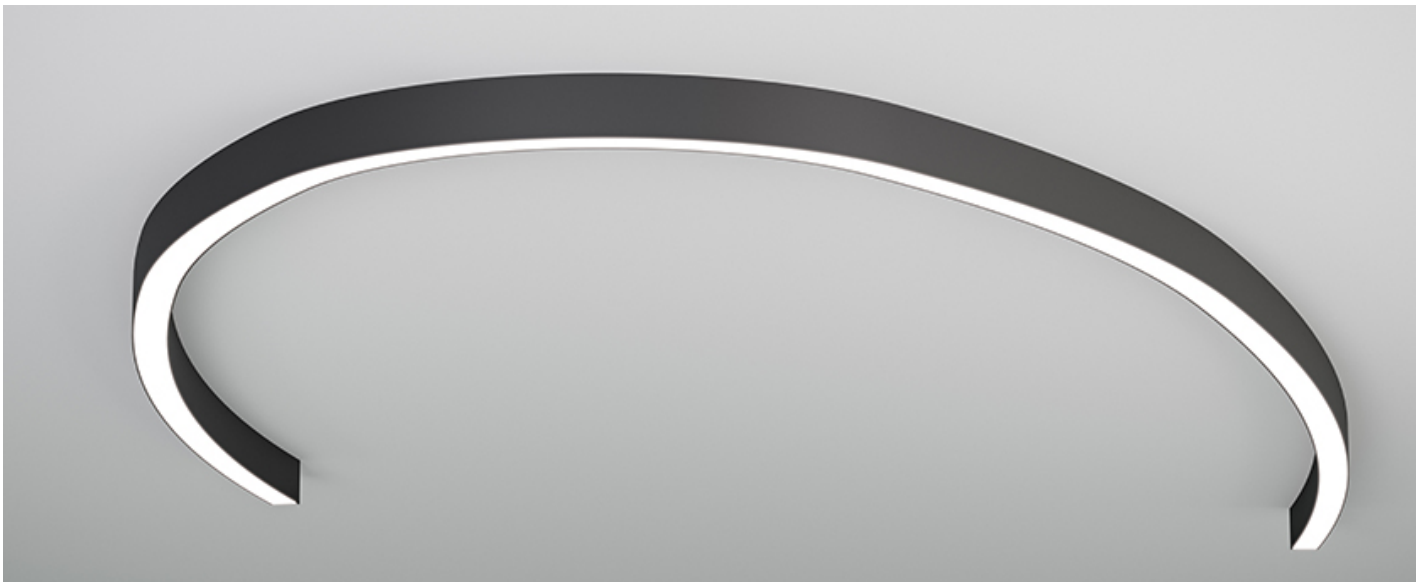

Project:	Type:
	Comments:

### Dimension and Mounting - Direct/Indirect Distribution (DI)

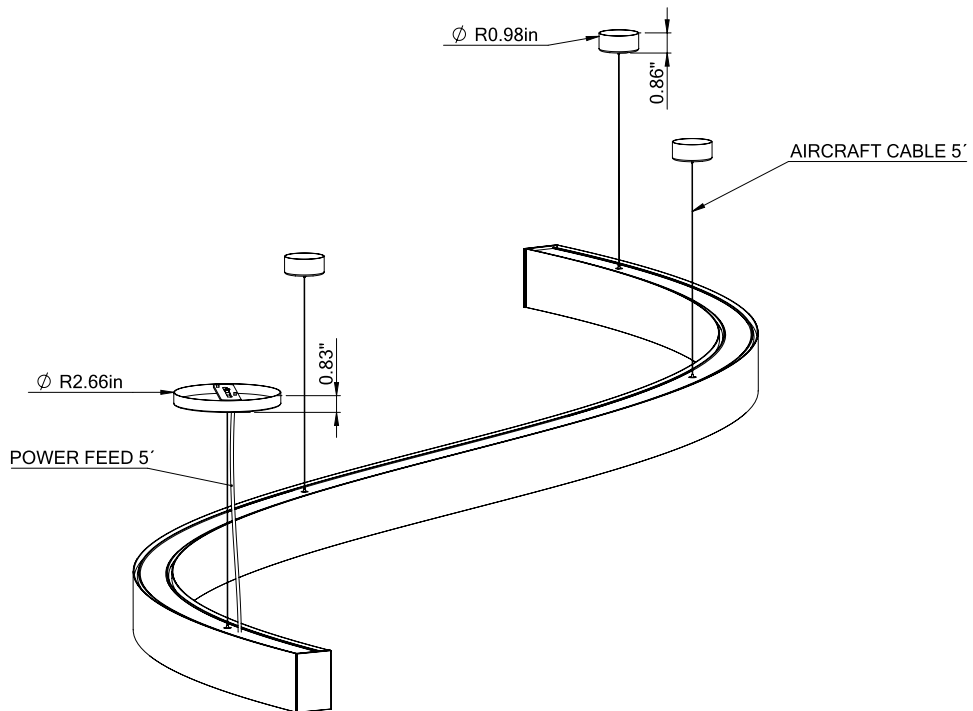
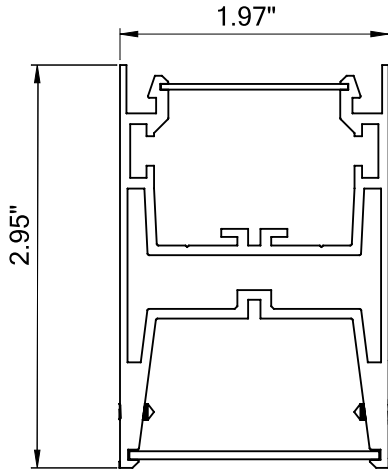

Project:	Type:
	Comments:

### Photometrics

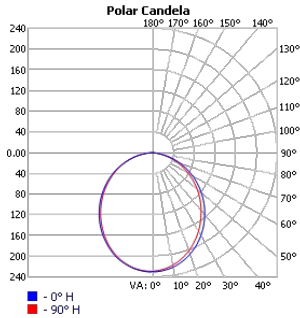

TECHOLED-BX-CURV-D-C-LO-30

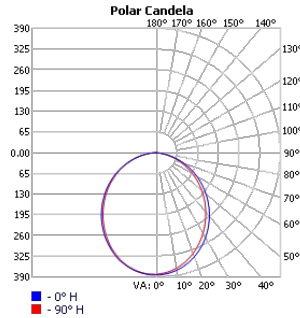

TECHOLED-BX-CURV-D-C-ME-30

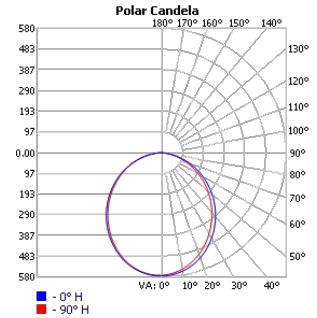

TECHOLED-BX-CURV-D-C-HI-30

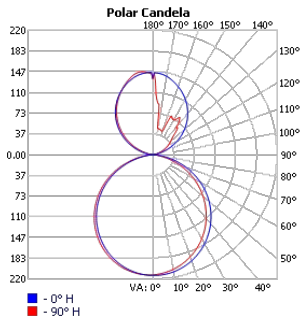

TECHOLED-BX-CURV-DI-C-LO-30

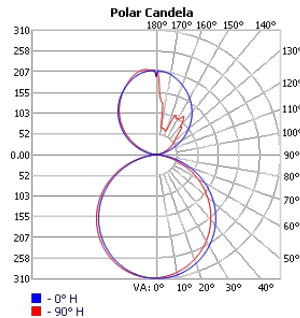

TECHOLED-BX-CURV-DI-C-ME-30

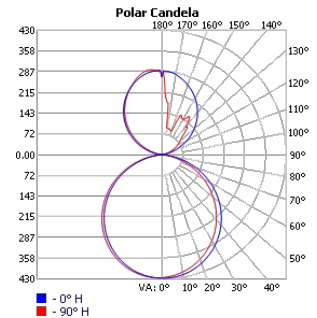

TECHOLED-BX-CURV-DI-C-HI-30

### Patterns Option Examples

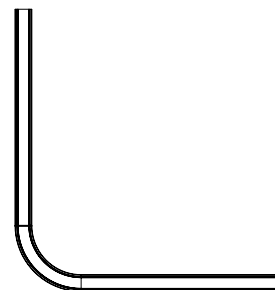
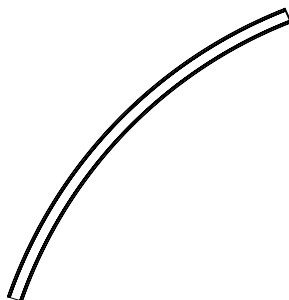
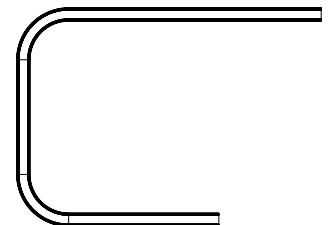
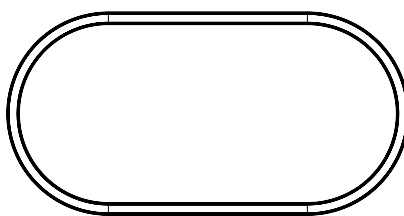
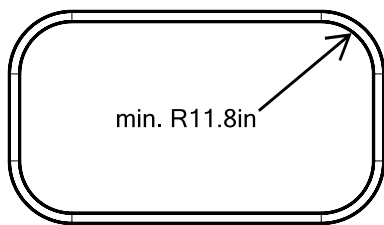

Project:	Type:
	Comments:

**Applications**



Project:	Type:
	Comments:

### Finish Details (powder coat finish)

#### ■ Standard Colors



#### ■ Custom Colors

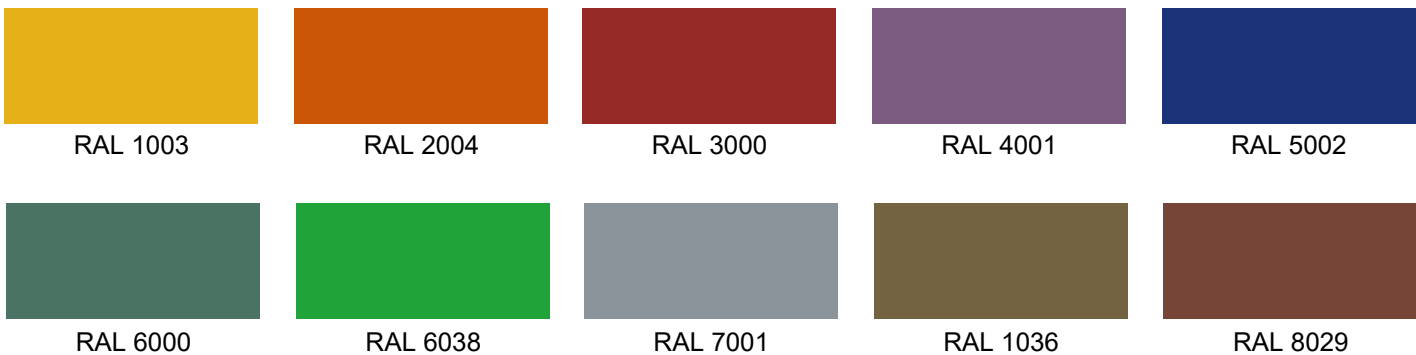

Any RAL color available, please refer to [ralcolorchart.com](http://ralcolorchart.com)

#### ■ Custom Wooden Colors

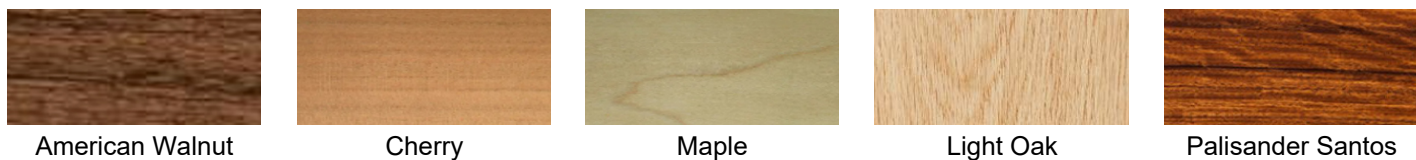

Project:	Type:
	Comments:

### Color Temperature

#### Color Temperature

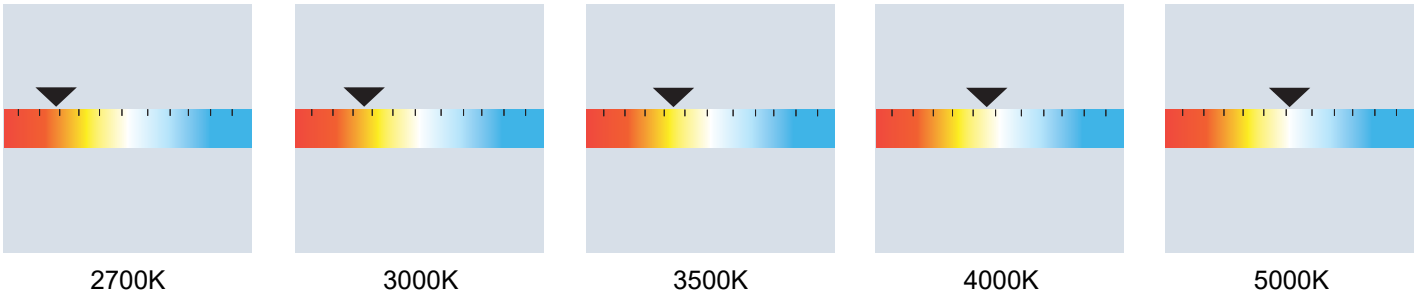

#### Tunable White

