

Project:	Type:
	Comments:



### Highlights

IP-2-R Series is specification grade, slim 2" outdoor architectural linear fixture, with IP65 - fully exposed to elements - rating, ability to do continuous linear runs. Recessed installation. Wide ranging customization options, from custom lumen packages, sizes and finishes. Great lighting solution for all modern exteriors.

**LED:** Samsung LED chips, 2700-5000K, tunable white and RGB/W available, 90CRI

**Optical:** Direct illumination, 106° beam angle

**Construction:** High grade aluminum extrusion, die cast end caps, PMMA diffuser, integral driver, powder coat finish, waterproof IP65, IK-10 impact rating, natatorium rating optional.

### Cross Section

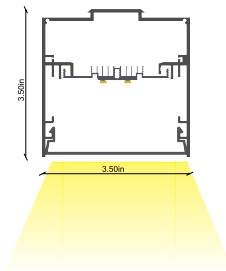

### Installation



Project:	Type:
	Comments:

### Configuration Example

Model #	Distribution	Length	Lumen Output	Color Temp.	Voltage	Color
TECHOLED-IP-R-D-4-LO-27-U-W	Direct	4'	Low	2700K	110-277V	White

### Ordering Guide:

Select one option from each group below. For a custom preference please contact [sales@techoled.com](mailto:sales@techoled.com)

1-FIXTURE ID		2-DISTRIBUTION		3-LENGTH		4-LUMEN OUTPUT	
<b>IP-R</b>	IP-R	<b>D</b>	Direct	<b>4</b>	4'	<b>LO</b>	Low
		<b>DWW</b>	Direct - Wall Wash	<b>6</b>	6'	<b>ME</b>	Medium
				<b>8</b>	8'	<b>HI</b>	High
				<b>C</b>	Custom		

5-COLOR TEMP.		6-VOLTAGE		7-FINISH		8-MOUNTING	
<b>27</b>	2700K	<b>U</b>	110-277V	<b>W</b>	White	<b>R</b>	Recessed
<b>30</b>	3000K	<b>HV</b>	347V	<b>S</b>	Silver		
<b>35</b>	3500K			<b>B</b>	Black		
<b>40</b>	4000K			<b>C</b>	Custom (RAL#)		
<b>50</b>	5000K						
<b>RGBW</b>	RGBW						
<b>D</b>	Tunable White						

9-DRIVER OPTIONS		10-OPTIONS		11-OPTIONS (CONT.)	
<b>DM</b>	0-10V Dimming	<b>RF-D</b>	Remote Tunable (RF only)	<b>EM</b>	EM Battery (remote)
<b>2C</b>	2 Channel	<b>RF-R</b>	Remote RGB/W (RF only)	<b>X</b>	None
<b>DM1%</b>	1% Dimming	<b>M</b>	Motion Sensor (remote)		
<b>LT1</b>	LDE1 Lutron 1%	<b>BM</b>	BubblyNet BT Mesh		
<b>DA</b>	Dali	<b>CS</b>	Casambi		
<b>DMX</b>	DMX	<b>AWN</b>	Lutron Athena Node		
<b>TR</b>	Triac Dimming	<b>AWNS</b>	Lutron Athena Node sensor		
<b>RF</b>	RF Wireless	<b>NL-ES7</b>	nLight - Wired		
<b>X</b>	None	<b>NL-AIR</b>	nLight - AIR		
		<b>NL-M</b>	nLight - Module only		
		<b>NT</b>	Natatorium Rating		
		<b>X</b>	None		

Project:	Type:
	Comments:

### Lumen Output Details

Model #	Length	Output	Color Temp.	Wattage	Lumen Output
TECHOLED-IP-R-D-4-LO-30	4'	Low	3000K	23W	2599Lm
TECHOLED-IP-R-D-4-ME-30	4'	Medium	3000K	34W	3842Lm
TECHOLED-IP-R-D-4-HI-30	4'	High	3000K	45W	5085Lm
TECHOLED-IP-R-D-6-LO-30	6'	Low	3000K	34W	3842Lm
TECHOLED-IP-R-D-6-ME-30	6'	Medium	3000K	51W	5763Lm
TECHOLED-IP-R-D-6-HI-30	6'	High	3000K	68W	7684Lm
TECHOLED-IP-R-D-8-LO-30	8'	Low	3000K	46W	5198Lm
TECHOLED-IP-R-D-8-ME-30	8'	Medium	3000K	68W	7684Lm
TECHOLED-IP-R-D-8-HI-30	8'	High	3000K	90W	10170Lm

Performance above applies to 90 CRI, 3000K. Calculate 96% for 2700K, 104% for 3500K and 109% for 4000K

### Performance

Output	Lumens / W	Direct	
		W / Ft	Lumens / ft
Low	113	5.8	650
Medium	113	8.5	960
High	113	11.3	1275

Project:	Type:
	Comments:

### Driver Option Details

Code	Description
LT1	<b>LDE1</b> - Lutron Hi-lume 1% EcoSystem, Soft-on, Fade-to Black Dimming
DA	<b>DALI</b>
DMX	<b>DMX</b> - Decoder provided by TechoLED, controller by others

### Controls Details

Code	Description
RF-D	<b>RF Wireless</b> remote controller for tunable white. <b>Default for tunable white.</b>
RF-R	<b>RF Wireless</b> remote controller for RGB & RGBW. <b>Default for RGB &amp; RGBW.</b>
M	<b>Motion Sensor</b> - remote, for integral sensor consult factory
BM	<b>Bluetooth Mesh</b> Smart Wireless Control by BubblyNet
CS	<b>Bluetooth Mesh</b> Smart Wireless Control by Casambi
AWNDR	<b>Lutron Athena</b> wireless node
AWNS	<b>Lutron Athena</b> wireless node with sensor
NL-ES7	<b>Acuity nLight</b> - Wired nES7 sensor
NL-AIR	<b>Acuity nLight</b> - AIR wireless rES7 sensor
NL-M	<b>Acuity nLight</b> - ready, sensor by others

Project:	Type:
	Comments:

### Dimension and Mounting - Direct Distribution (D)

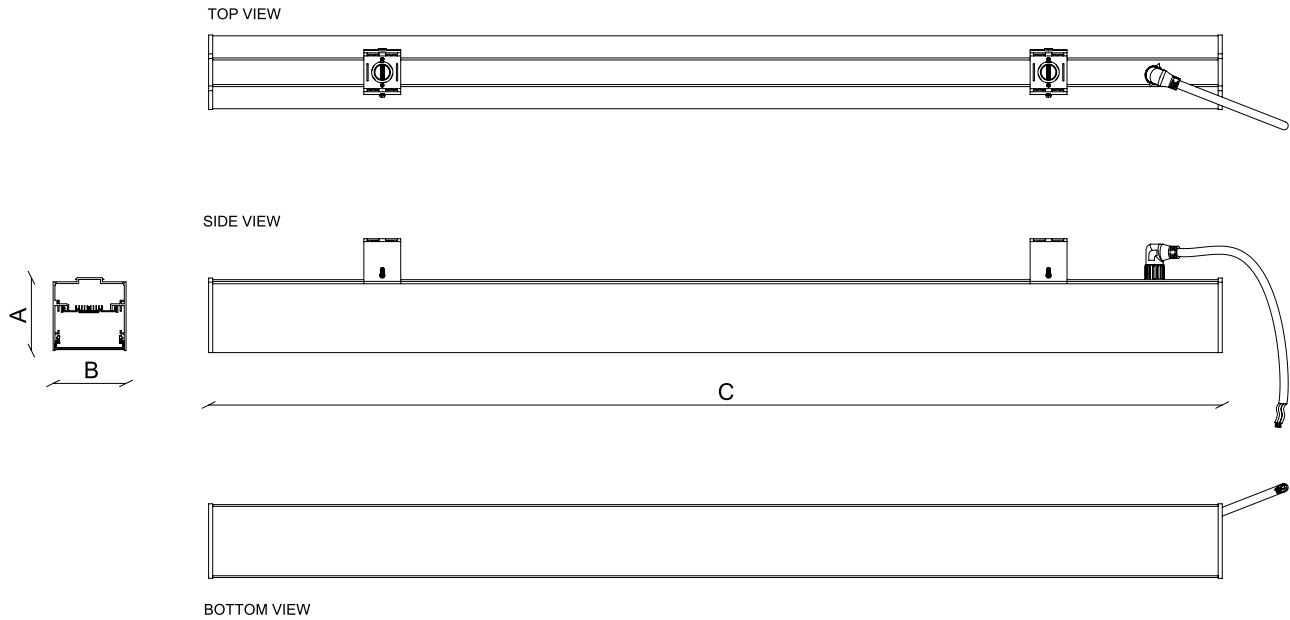

FIXTURE ID	A	B	C
IP-R-D-4	3.58"	3.58"	48.70"
IP-R-D-6	3.58"	3.58"	72.68"
IP-R-D-8	3.58"	3.58"	96.69"

Project:	Type:
	Comments:

### ■ Recessed Mount (threaded rod by others)

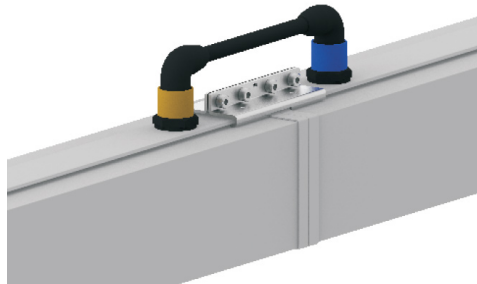
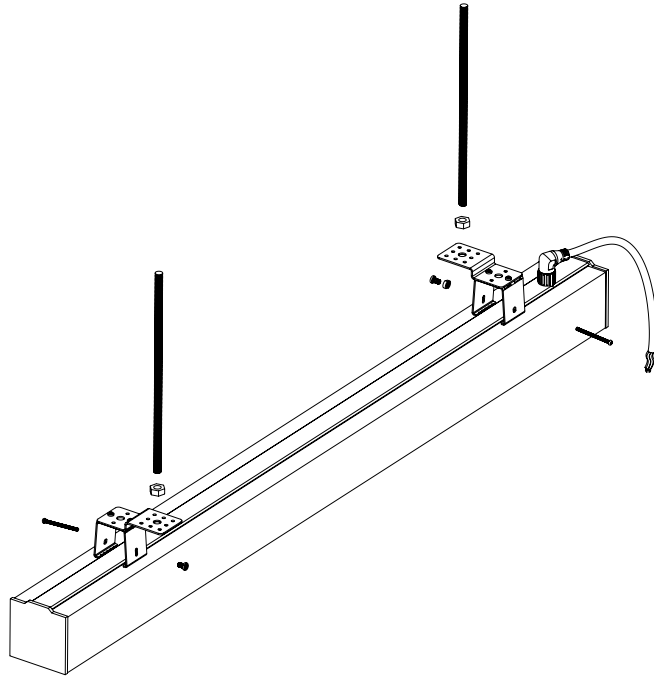
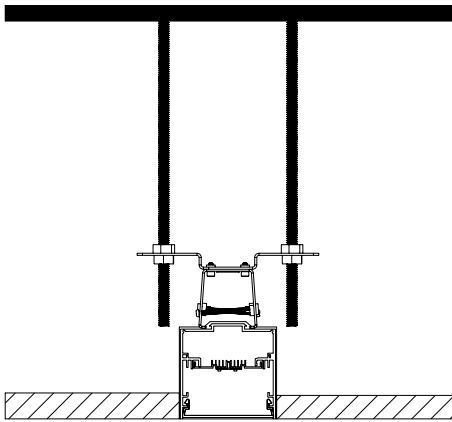

Continuous run

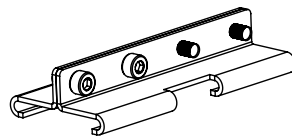

IP66-180

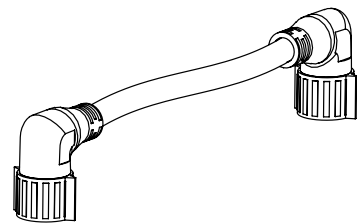

IP66-CH

### Recessed Kit

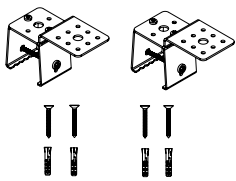

IP66-BI

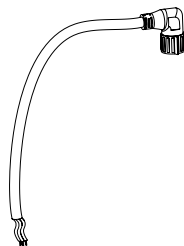

P-M19-5-6FT

Project:	Type:
	Comments:

**Photometrics**

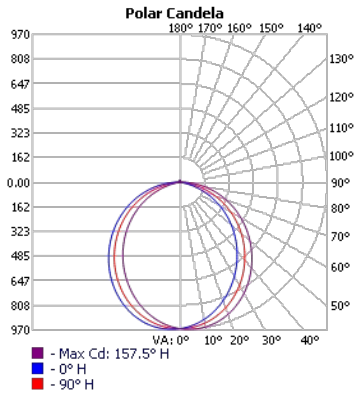

TECHOLED-IP-R-D-4-LO-30

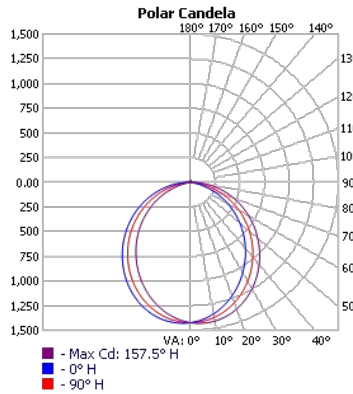

TECHOLED-IP-R-D-4-ME-30

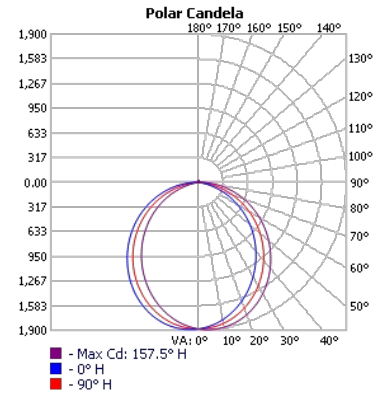

TECHOLED-IP-R-D-4-HI-30

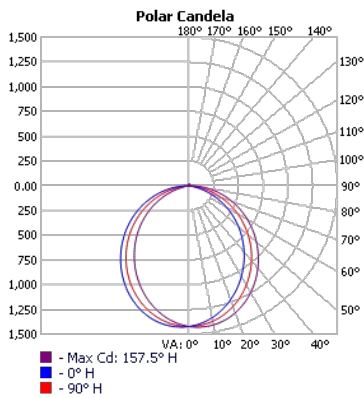

TECHOLED-IP-R-D-6-LO-30

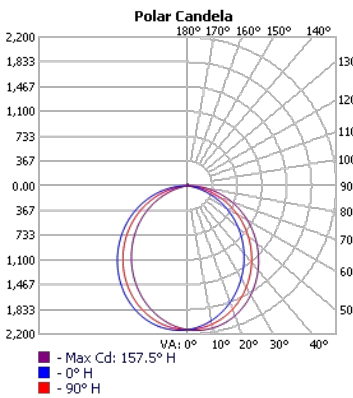

TECHOLED-IP-R-D-6-ME-30

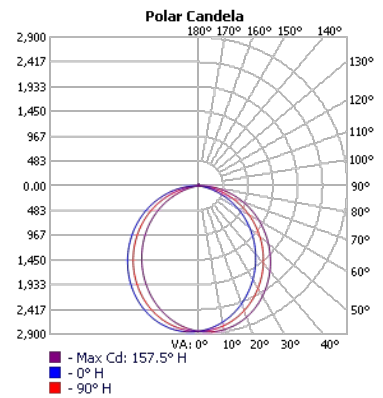

TECHOLED-IP-R-D-6-HI-30

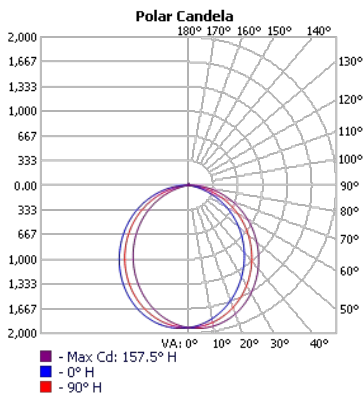

TECHOLED-IP-R-D-8-LO-30

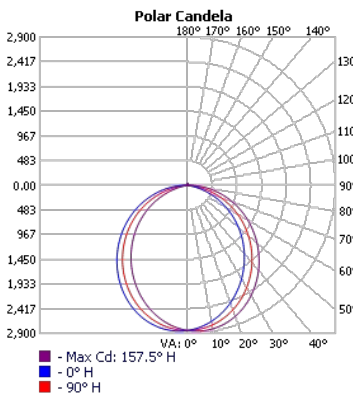

TECHOLED-IP-R-D-8-ME-30

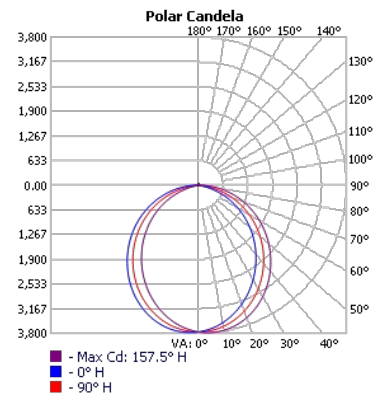

TECHOLED-IP-R-D-8-HI-30

Project:	Type:
	Comments:

### Finish Details (powder coat finish)

#### ■ Standard Colors



#### ■ Custom Colors

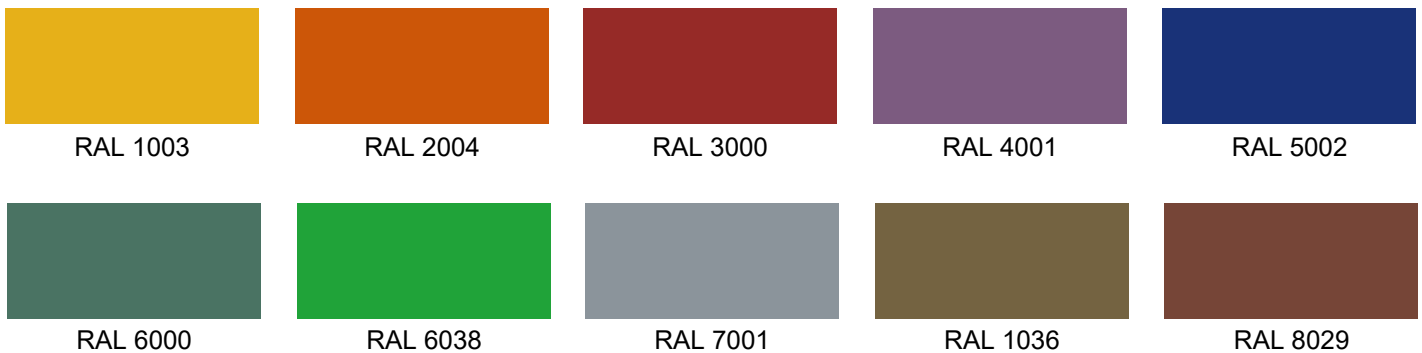

Any RAL color available, please refer to [ralcolorchart.com](http://ralcolorchart.com)

#### ■ Custom Wooden Colors

