

Project:	Type:
	Comments:



Highlights

IP Series is specification grade, outdoor architectural linear fixture, with IP66 - fully exposed to elements - rating, ability to do continuous linear runs. Offered in pendant, surface or all mounted versions. Wide ranging customization options, from custom lumen packages, sizes and finishes. Great lighting solution for all modern exteriors.

LED: Samsung LED chips, 2700-5000K, tunable white and RGB/W available, 90CRI

Optical: Direct and Direct/Indirect illumination, 106° beam angle

Construction: High grade aluminum extrusion, die cast end caps, PMMA diffuser, integral driver, powder coat finish, waterproof IP66, IK 10 impact rating, natatorium rating optional

Cross Section

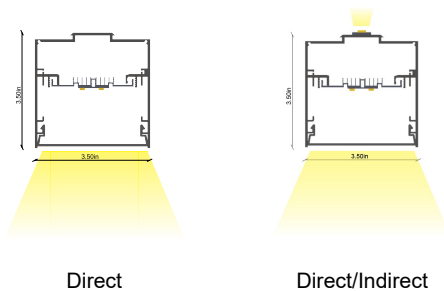

Installation

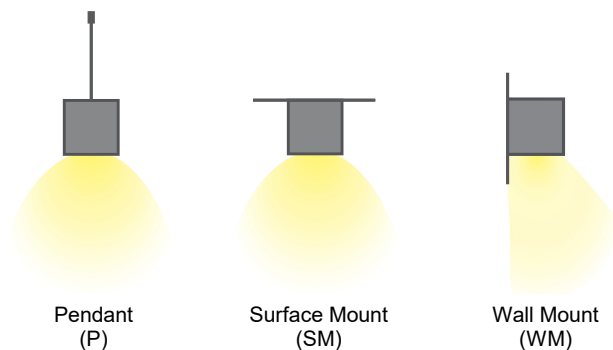

Project:	Type:
	Comments:

Configuration Example

Model #	Distribution	Length	Lumen Output	Color Temp.	Voltage	Color
TECHOLED-IP-D-4-LO-30-U-W	Direct	4'	Low	3000K	100-277V	White

Ordering Guide:

Select one option from each group below. For a custom preference please contact sales@techoled.com

1-FIXTURE ID		2-DISTRIBUTION		3-LENGTH		4-LUMEN OUTPUT	
IP	IP	D	Direct	4	4'	LO	Low
		DI	Direct/Indirect	6	6'	ME	Medium
		DI2	D/I2-circuit	8	8'	HI	High
		DWW	Direct, Wall Wash	C	Custom		

5-COLOR TEMP.		6-VOLTAGE		7-FINISH		8-MOUNTING	
27	2700K	U	110-277V	S	Silver	P	Pendant
30	3000K	HV	347V	W	White	SM	Surface Mount
35	3500K			B	Black	W	Wall Mount
40	4000K			C	Custom (RAL#)		
50	5000K						
RGBW	RGBW						
D	Tunable White						

9-DRIVER OPTIONS		10-OPTIONS		11-OPTIONS (CONT.)	
DM	0-10V Dimming	RF-D	Remote Tunable (RF only)	EM	EM Battery (remote)
2C	2 Channel	RF-R	Remote RGB/W (RF only)	X	None
DM1%	1% Dimming	M	Motion Sensor (remote)		
LT1	LDE1 Lutron 1%	BM	BubblyNet BT Mesh		
DA	Dali	CS	Casambi		
DMX	DMX	AWNR	Lutron Athena Node		
TR	Triac Dimming	AWNS	Lutron Athena Node sensor		
RF	RF Wireless	NL-ES7	nLight - Wired		
X	None	NL-AIR	nLight - AIR		
		NL-M	nLight - Module only		
		NT	Natatorium Rating		
		X	None		

Project:	Type:
	Comments:

Lumen Output Details

Model #	Length	Output	Color Temp.	Wattage	Lumen Output
TECHOLED-IP-D-4-LO-30	4'	Low	3000K	23W	2599Lm
TECHOLED-IP-D-4-ME-30	4'	Medium	3000K	34W	3842Lm
TECHOLED-IP-D-4-HI-30	4'	High	3000K	45W	5085Lm
TECHOLED-IP-D-6-LO-30	6'	Low	3000K	34W	3842Lm
TECHOLED-IP-D-6-ME-30	6'	Medium	3000K	51W	5763Lm
TECHOLED-IP-D-6-HI-30	6'	High	3000K	68W	7684Lm
TECHOLED-IP-D-8-LO-30	8'	Low	3000K	46W	5198Lm
TECHOLED-IP-D-8-ME-30	8'	Medium	3000K	68W	7684Lm
TECHOLED-IP-D-8-HI-30	8'	High	3000K	90W	10170Lm

Performance above applies to 90 CRI, 3000K. Calculate 96% for 2700K, 104% for 3500K and 109% for 4000K

Model #	Length	Output	Color Temp.	Wattage	Down Lumen Out.	Up Lumen Out.
TECHOLED-IP-DI-4-LO-30	4'	Low	3000K	41W	2599Lm	1668Lm
TECHOLED-IP-DI-4-ME-30	4'	Medium	3000K	52W	3842Lm	1668Lm
TECHOLED-IP-DI-4-HI-30	4'	High	3000K	63W	5085Lm	1668Lm
TECHOLED-IP-DI-6-LO-30	6'	Low	3000K	60W	3842Lm	2502Lm
TECHOLED-IP-DI-6-ME-30	6'	Medium	3000K	77W	5763Lm	2502Lm
TECHOLED-IP-DI-6-HI-30	6'	High	3000K	94W	7684Lm	2502Lm
TECHOLED-IP-DI-8-LO-30	8'	Low	3000K	81W	5198Lm	3336Lm
TECHOLED-IP-DI-8-ME-30	8'	Medium	3000K	103W	7684Lm	3336Lm
TECHOLED-IP-DI-8-HI-30	8'	High	3000K	125W	10170Lm	3336Lm

Performance above applies to 90 CRI, 3000K. Calculate 96% for 2700K, 104% for 3500K and 109% for 4000K

■ Performance

Output	Lumens / W	Direct		Indirect		
		W / Ft	Lumens / ft	Lumens / W	W / Ft	Lumens / ft
Low	113	5.8	650	95	4.4	417
Medium	113	8.5	960	95	4.4	417
High	113	11.3	1275	95	4.4	417

Project:	Type:
	Comments:

Driver Option Details

Code	Description
LT1	LDE1 -Lutron Hi-lume 1% EcoSystem, Soft-on, Fade-to Black Dimming
DA	DALI
DMX	DMX - Decoder provided by TechoLED, controller by others

Controls Details

Code	Description
RF-D	RF Wireless remote controller for tunable white. Default for tunable white.
RF-R	RF Wireless remote controller for RGB & RGBW. Default for RGB & RGBW.
M	Motion Sensor - remote, for integral sensor consult factory
BM	Bluetooth Mesh Smart Wireless Control by BubblyNet
CS	Bluetooth Mesh Smart Wireless Control by Casambi
AWNR	Lutron Athena wireless node
AWNS	Lutron Athena wireless node with sensor
NL-ES7	Acuity nLight – Wired nES7 sensor
NL-AIR	Acuity nLight – AIR wireless rES7 sensor
NL-M	Acuity nLight - ready, sensor by others

Options (cont.) Details

Code	Description
EM	Emergency Battery Backup (remote)

Project:	Type:
Comments:	

Dimension and Mounting - Direct Distribution (D)

TOP VIEW

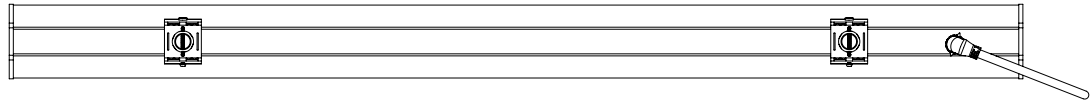

SIDE VIEW

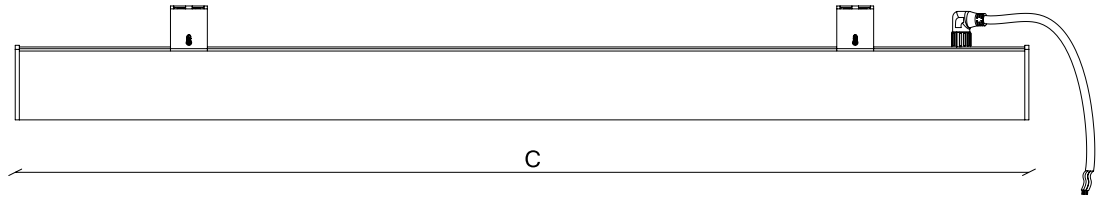
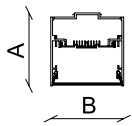

BOTTOM VIEW

FIXTURE ID	A	B	C
IP-D-4	3.58"	3.58"	48.70"
IP-D-6	3.58"	3.58"	72.68"
IP-D-8	3.58"	3.58"	96.69"

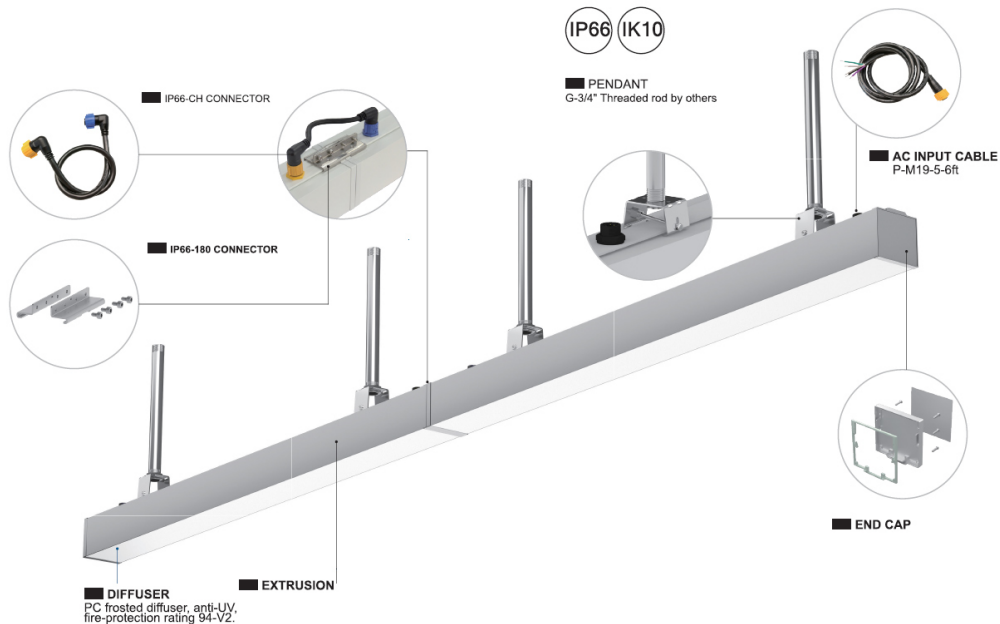

Project:	Type:
	Comments:

■ Pendant (threaded rod/stem not included)

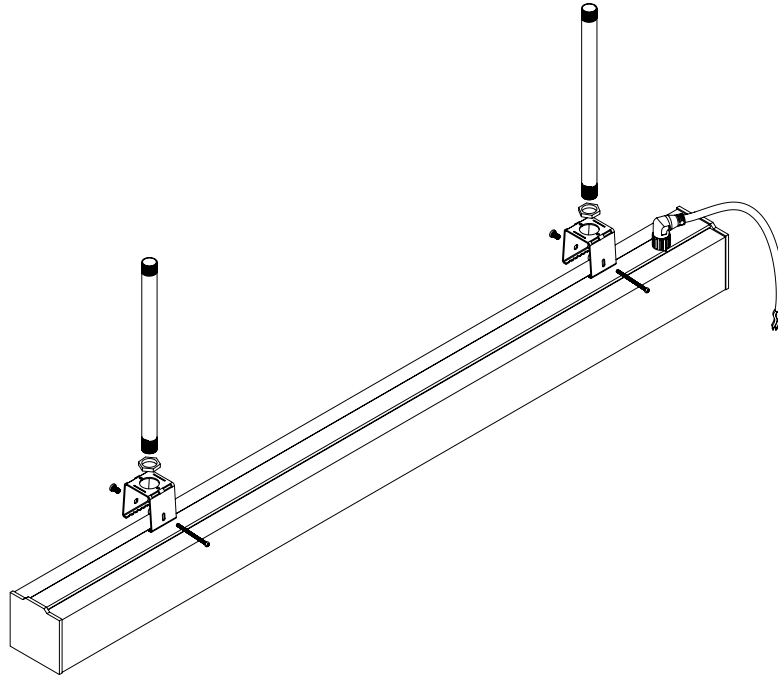
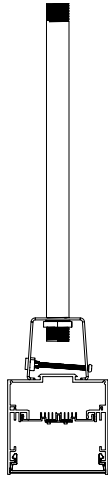

■ PENDANT
G-3/4" Threaded rod by others

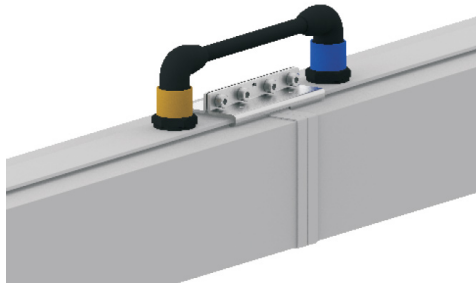

Continuous run

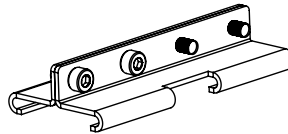

IP66-180

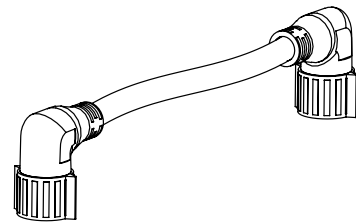

IP66-CH

■ Pendant Kit

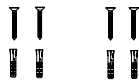
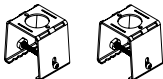

IP66-PT

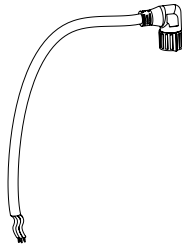

P-M19-5-6FT

Project:	Type:
	Comments:

■ Surface Mount

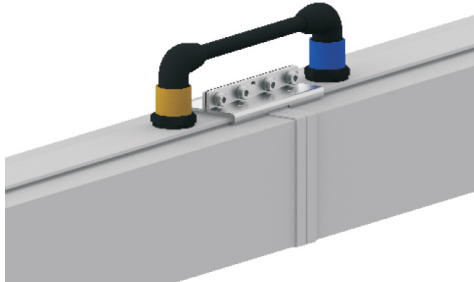
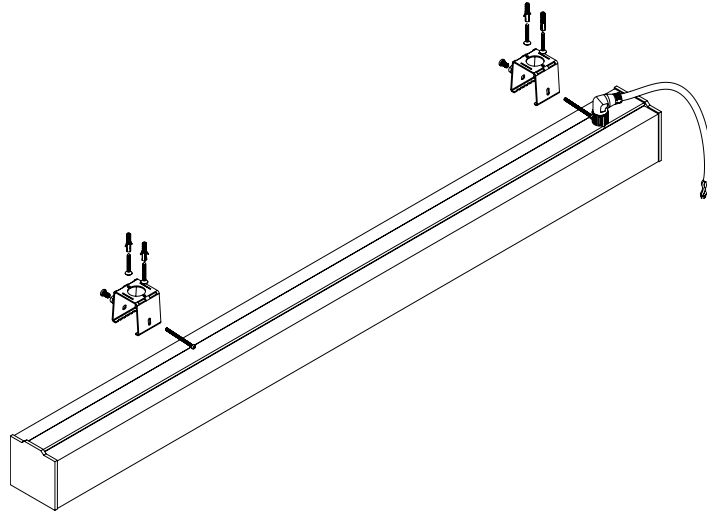
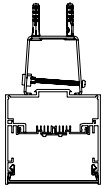

Continuous run

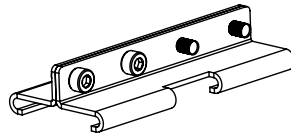

IP66-180

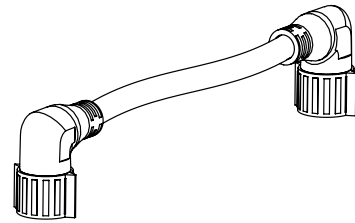

IP66-CH

■ Surface Mount Kit

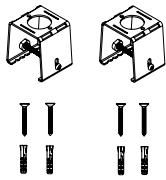

IP66-PT

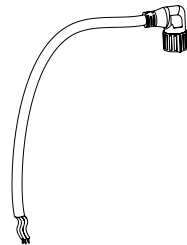

P-M19-5-6FT

Project:	Type:
	Comments:

■ Wall Mount

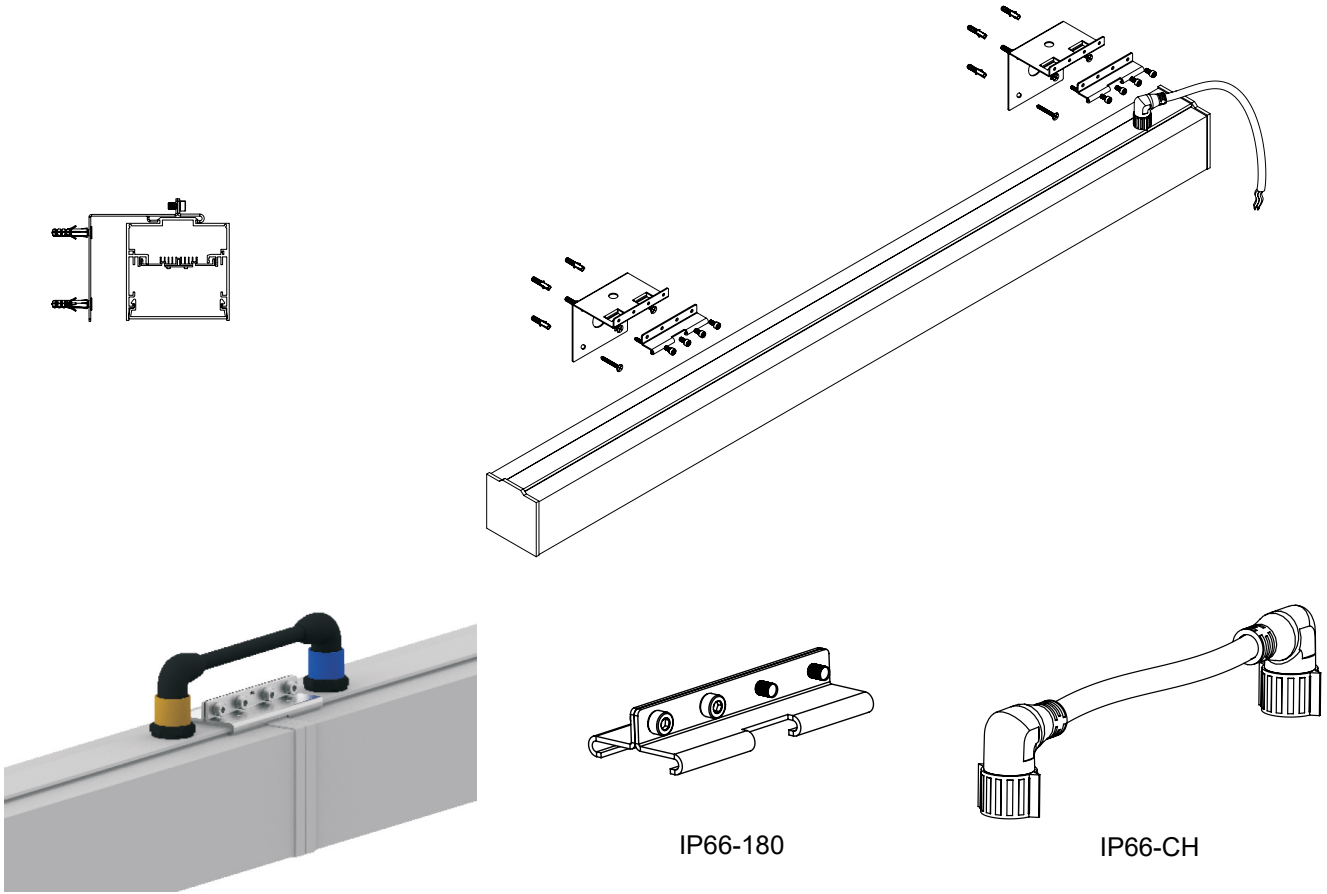

Continuous run

■ Wall Mount Kit

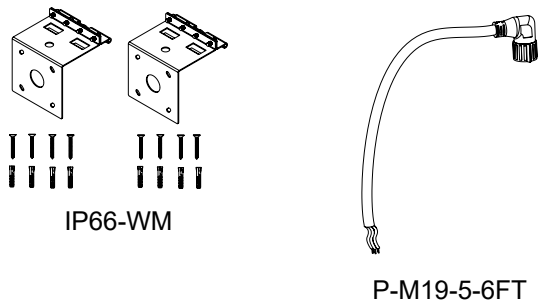

IP66-WM

P-M19-5-6FT

Project:	Type:
	Comments:

Dimension and Mounting - Direct/Indirect Distribution (DI)

■ Pendant (threaded rod/stem not included) (DI)

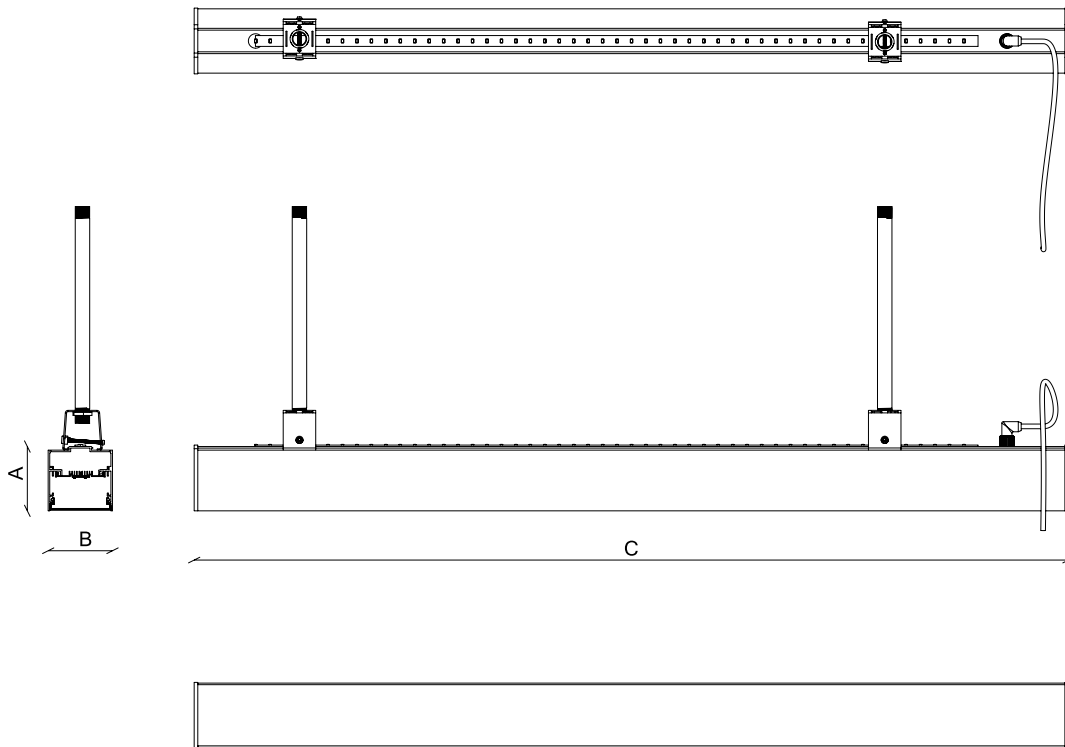

FIXTURE ID	A	B	C
IP-DI-4	3.58"	3.58"	48.70"
IP-DI-6	3.58"	3.58"	72.68"
IP-DI-8	3.58"	3.58"	96.69"



■ PENDANT
G-3/4" Threaded rod by others

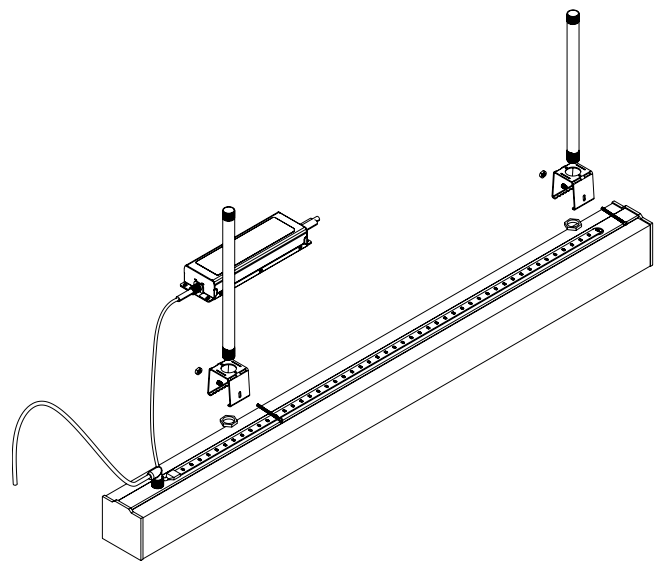

Project:	Type:
	Comments:

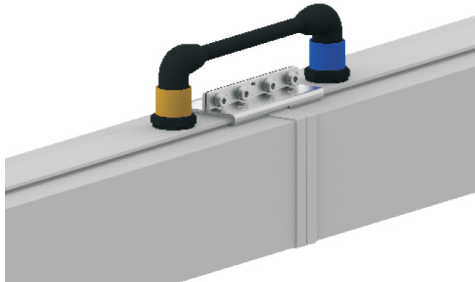

Continuous run

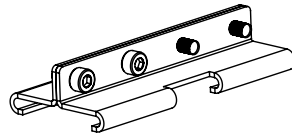

IP66-180

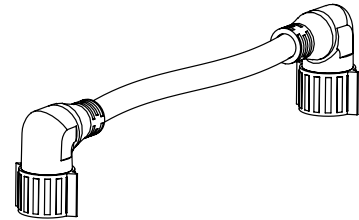

IP66-CH

■ Pendant Kit

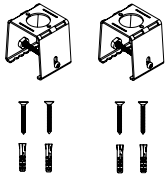

IP66-PT

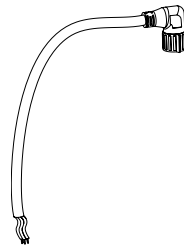

P-M19-5-6FT

Project:	Type:
	Comments:

■ Wall Mount (DI)

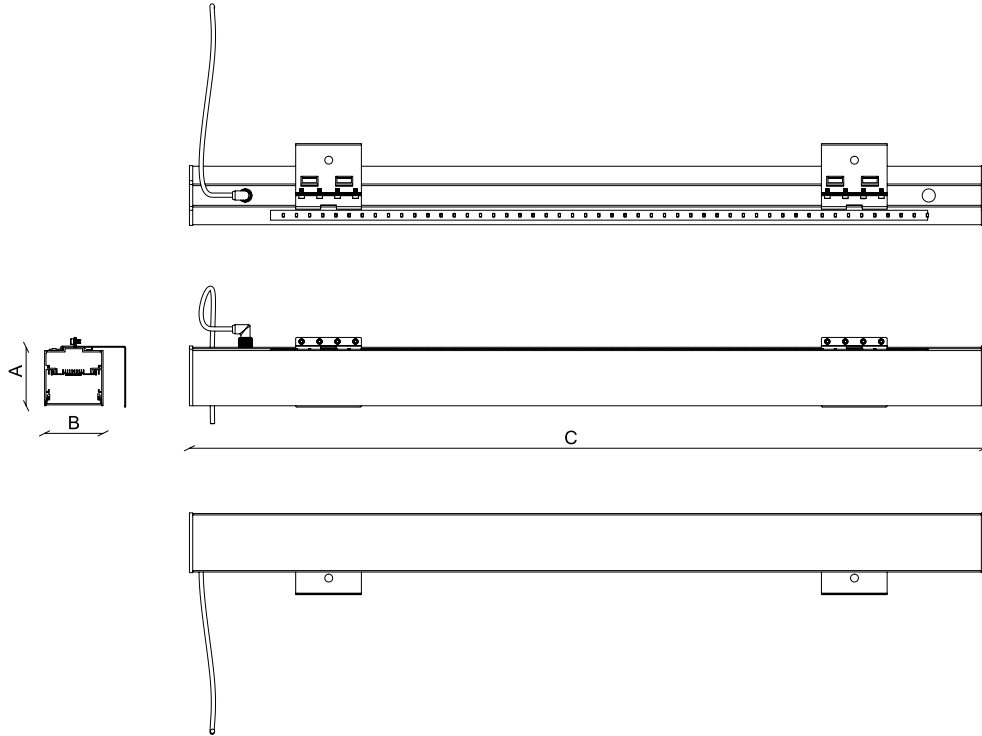

FIXTURE ID	A	B	C
IP-DI-4	3.58"	3.58"	48.70"
IP-DI-6	3.58"	3.58"	72.68"
IP-DI-8	3.58"	3.58"	96.69"

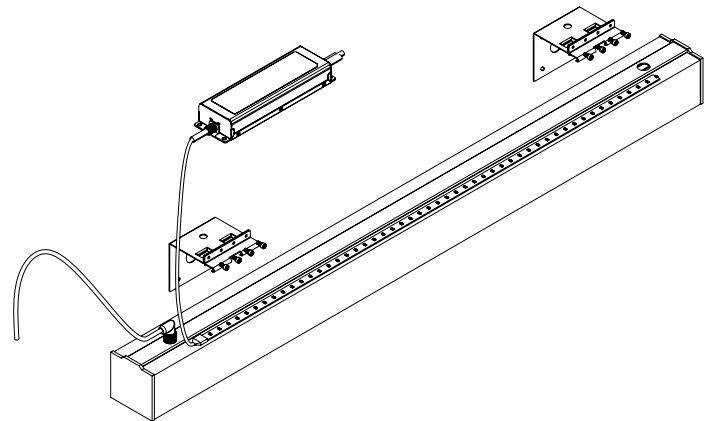

Project:	Type:
	Comments:

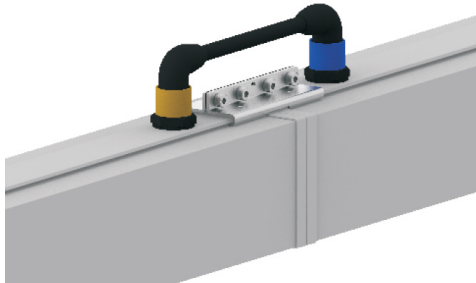

Continuous run

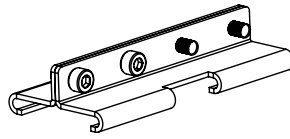

IP66-180

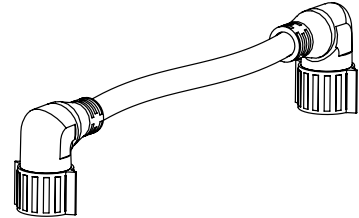

IP66-CH

■ Wall Mount Kit

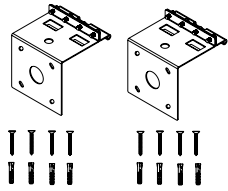

IP66-WM

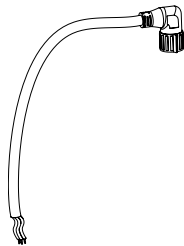

P-M19-5-6FT

Project:	Type:
	Comments:

Photometrics

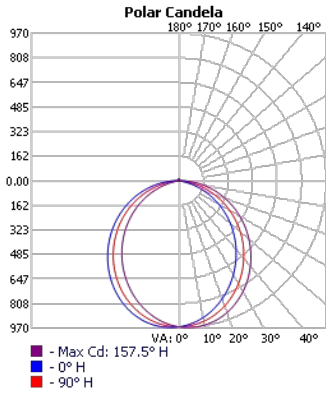

TECHOLED-IP-D-4-LO-30

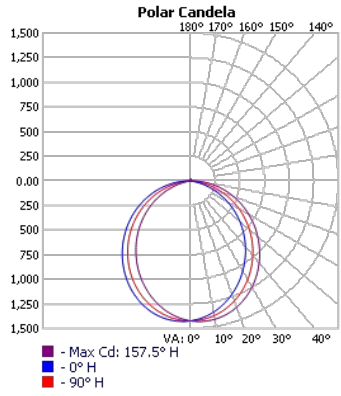

TECHOLED-IP-D-4-ME-30

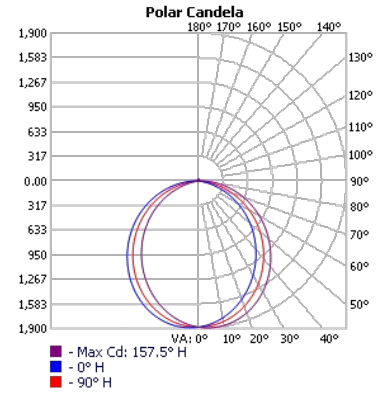

TECHOLED-IP-D-4-HI-30

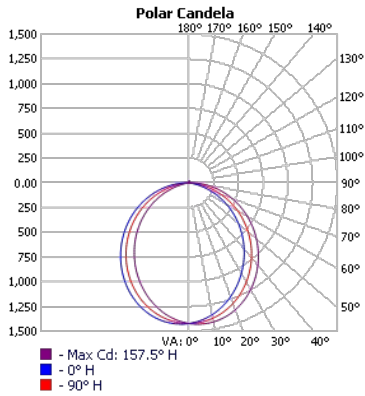

TECHOLED-IP-D-6-LO-30

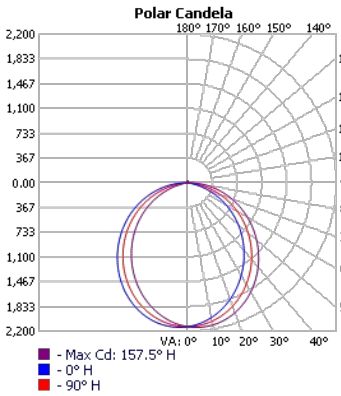

TECHOLED-IP-D-6-ME-30

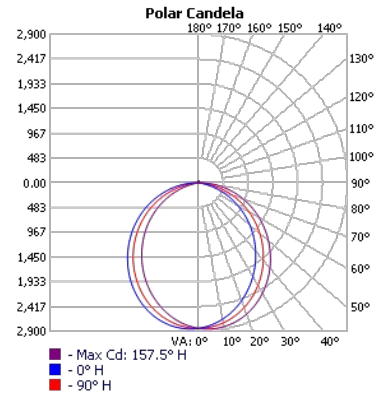

TECHOLED-IP-D-6-HI-30

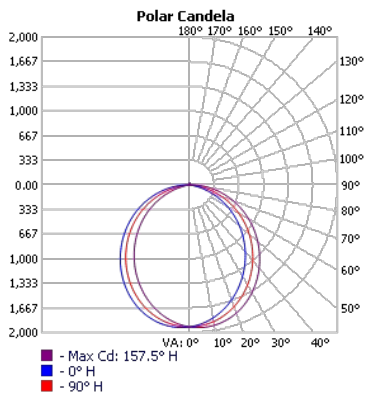

TECHOLED-IP-D-8-LO-30

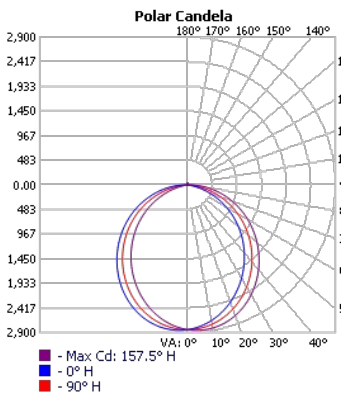

TECHOLED-IP-D-8-ME-30

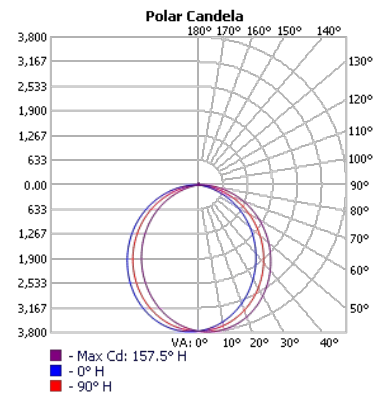

TECHOLED-IP-D-8-HI-30

Project:	Type:
	Comments:

Finish Details (powder coat finish)

Standard Colors



Custom Colors

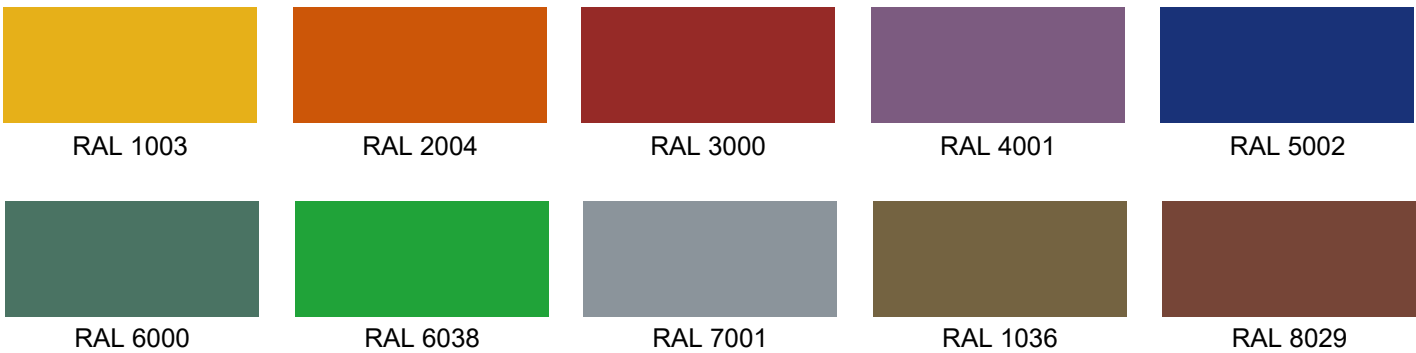

Any RAL color available, please refer to ralcolorchart.com

Custom Wooden Colors

