

Project:	Type:
	Comments:

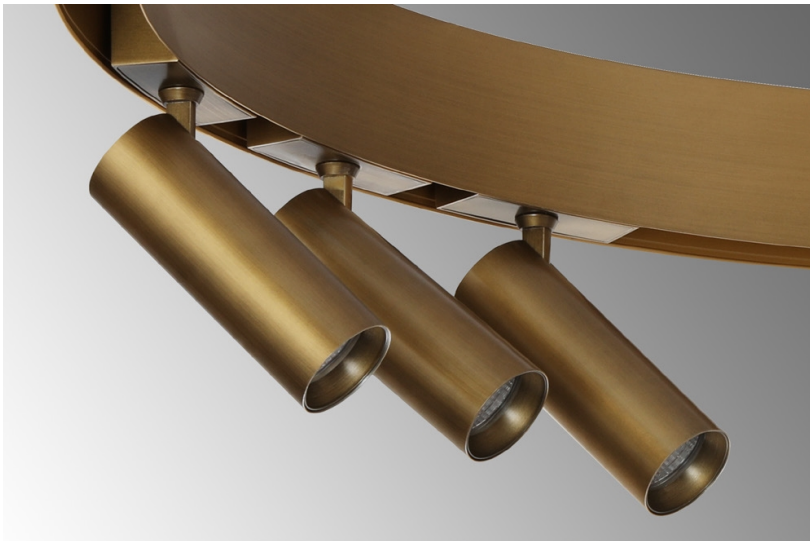

Highlights

The TechoLED Magnetic Track System is a creative and flexible architectural lighting solution. The track has virtually unlimited capability to create shapes and patterns, from simple rectangles to complex curves and circles, including custom radii with both the track and the illuminated modules. Light components, ranging from solid linear, louvre, and wall washer to adjustable spotlights and pendant cylinders, snap into the track magnetically and can be repositioned by hand without tools. It is a superb and creative lighting solution for any modern interior.

LED: Osram & Cree LED Chips, 2700-5000K, dim-to-warm and tunable white available, 90+ CRI

OPTICAL: Direct illumination, 18° - 40° beam angles available

CONSTRUCTION: High grade aluminum extrusion, powder coat finish, custom finishes available, 24V remote driver

Cross Section

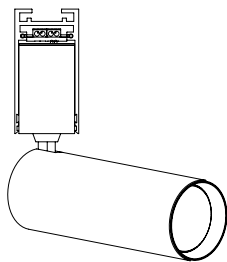

Installation

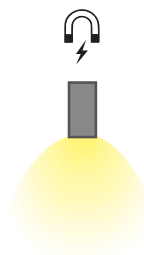

Project:	Type:
	Comments:

Configuration Example

Model #	Lumen Output	Beam Angle	Color Temp.	Finish	Contr. Options
TECHOLED-MCT-S-10-ME-18-30-W-X	Medium	18°	3000K	White	None (single)

Ordering Guide:

Select one option from each group below. For a custom preference please contact sales@techoled.com

1-FIXTURE ID	2-LUMEN OUTPUT	3-BEAM ANGLE	4-COLOR TEMPERATURE
MCT-S- MCT S 10	ME Medium	18 18°	27 2700K
		36 36°	30 3000K
			35 3500K
			40 4000K
			50 5000K
			D Tunable White
			DM Dim to Warm

5-FINISH	6-CONTROLLER OPTIONS	7-SPOTLIGHT OPTIONS
B Black	X None	H Honeycomb
W White	DC Double Circuit	X None
C Custom (RAL#)	CA Casambi	
	DA Dali	

Project:	Type:
	Comments:

Lumen Output Details

Model #	Output	Beam Angle	Color Temp.	Wattage	Lumen Output
TECHOLED-MCT-S-10-ME-36-30-W-X	Medium	36°	3000K	10W	650Lm

Performance above applies to 90CRI, 3000K. Calculate 96% for 2700K, 104% for 3500K and 109% for 4000K.

Performance

Output	Lumens / W
Medium	65

Fixture ID Details

Code	Description
MCT-S-10	10W Adjustable Spotlight Module

Controller Options Details

Code	Description
X	None - only works with Single Circuit track
DC	Double Circuit - only works with Double Circuit track
CA	Casambi - only works with Casambi Circuit track
DA	Dali - only works with Casambi Circuit track and Dali driver

Project:	Type:
	Comments:

Dimension and Mounting

TECHOLED-MCT-S-10

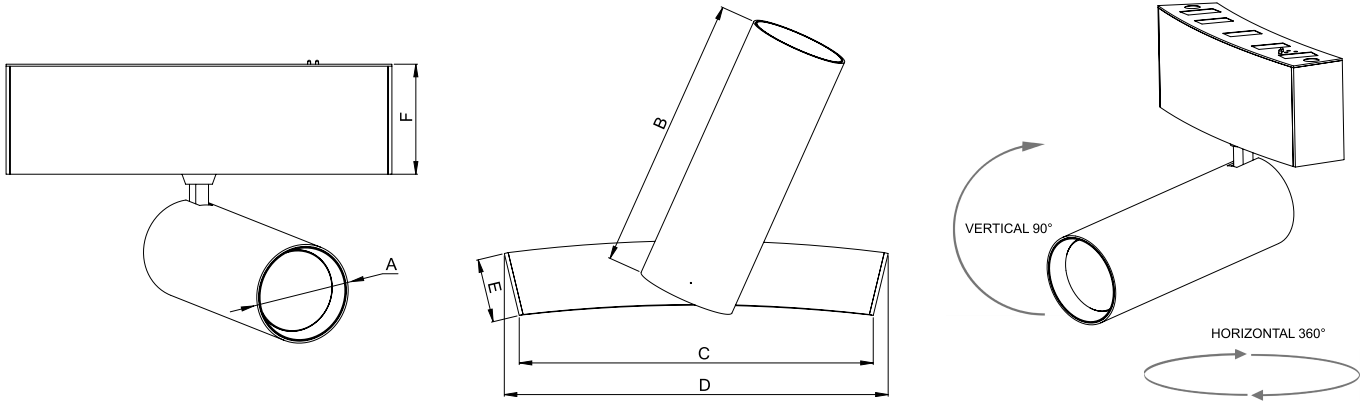

FIXTURE ID	A	B	C	D	E
MCT-S-10	1.96"	5.5"	5.43"	2.16"	1.34"

Project:	Type:
	Comments:

Photometrics

TECHOLED-MCT-S-10

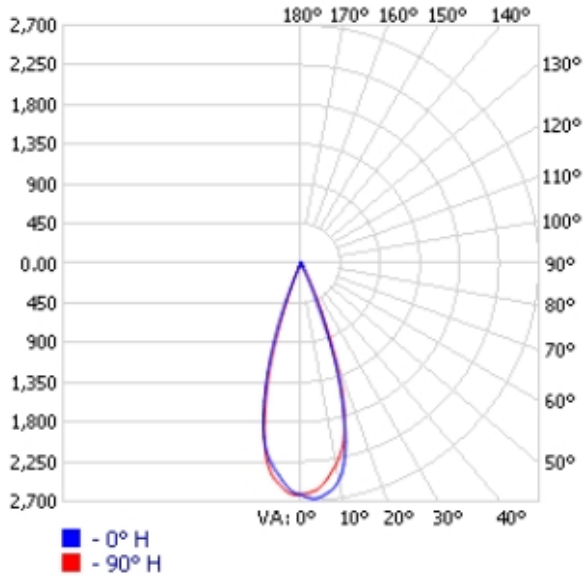

Project:	Type:
	Comments:

Finish Details (powder coat finish)

Standard Colors

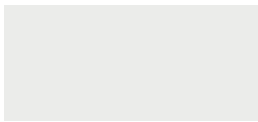

W – White



B – Black

Custom Colors



RAL 1003



RAL 2004



RAL 3000



RAL 4001



RAL 5002



RAL 6000



RAL 6038



RAL 7001



RAL 1036



RAL 8029

Any RAL color available, please refer to ralcolorchart.com

Custom Wooden Colors



American Walnut

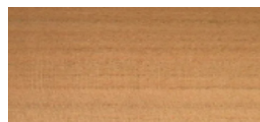

Cherry



Maple



Light Oak



Palisander Santos

Project:	Type:
	Comments:

Color Temperature

Color Temperature

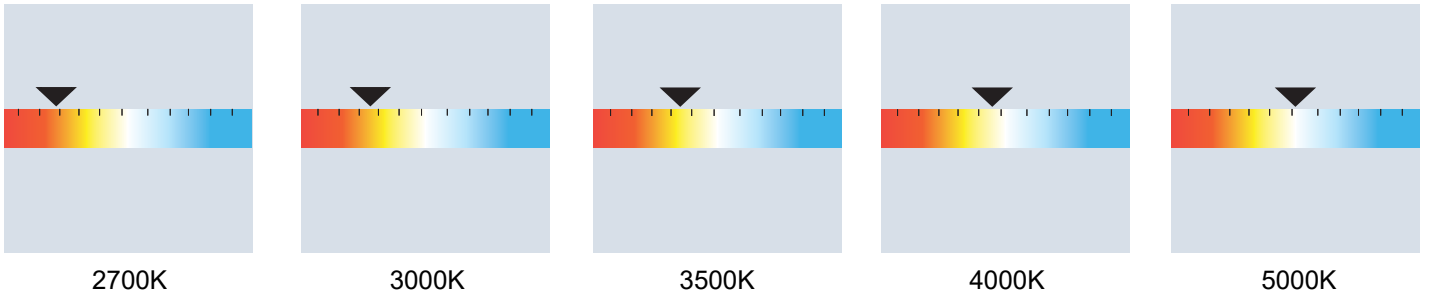

Tunable White

