

Project:	Type:
	Comments:



### Highlights

The TechoLED Magnetic Track System is a creative and flexible architectural lighting solution. The track has virtually unlimited capability to create shapes and patterns, from simple rectangles to complex curves and circles, including custom radii with both the track and the illuminated modules. Light components, ranging from solid linear, louvre, and wall washer to adjustable spotlights and pendant cylinders, snap into the track magnetically and can be repositioned by hand without tools. It is a superb and creative lighting solution for any modern interior.

**LED:** Osram & Cree LED Chips, 2700-5000K, dim-to-warm and tunable white available, 90+ CRI

**OPTICAL:** Direct illumination, 20° - 60° field adjustable beam angle

**CONSTRUCTION:** High grade aluminum extrusion, powder coat finish, custom finishes available, 24V remote driver, field adjustable beam angle

### Cross Section

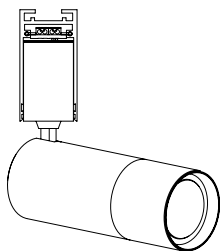

### Installation

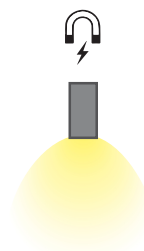

Project:	Type:
	Comments:

### Configuration Example

Model #	Lumen Output	Beam Angle	Color Temp.	Finish	Contr. Options
TECHOLED-MT-FM-10-ME-ADJ-30-W-X	Medium	Adjustable (20°-60°)	3000K	White	None (single)

### Ordering Guide:

Select one option from each group below. For a custom preference please contact [sales@techoled.com](mailto:sales@techoled.com)

1-FIXTURE ID	2-LUMEN OUTPUT	3-BEAM ANGLE	4-COLOR TEMPERATURE	
<b>MT-FM-10</b>	<b>ME</b> Medium	<b>ADJ</b> Adjustable (20°-60°)	<b>27</b>	2700K
			<b>30</b>	3000K
			<b>35</b>	3500K
			<b>40</b>	4000K
			<b>50</b>	5000K
			<b>D</b>	Tunable White
			<b>DM</b>	Dim to Warm

5-FINISH		6-CONTROLLER OPTIONS	
<b>B</b>	Black	<b>X</b>	None
<b>W</b>	White	<b>DC</b>	Double Circuit
<b>C</b>	Custom (RAL#)	<b>CA</b>	Casambi
		<b>DA</b>	Dali
		<b>WL</b>	Wireless

Project:	Type:
	Comments:

**Lumen Output Details**

Model #	Output	Color Temp.	Wattage	Lumen Output
TECHOLED-MT-FM-10-ME-ADJ-30-W-X	Medium	3000K	10W	810Lm

Performance above applies to 90CRI, 3000K. Calculate 96% for 2700K, 104% for 3500K and 109% for 4000K.

**Performance**

Output	Lumens / W
Medium	81

**Fixture ID Details**

Code	Description
MT-FM-10	10W Adjustable Spotlight Focus Module

**Controller Options Details**

Code	Description
X	None - only works with Single Circuit track
DC	Double Circuit - only works with Double Circuit track
CA	Casambi - only works with Casambi Circuit track
DA	Dali - only works with Casambi Circuit track and Dali driver
WL	Wireless

Project:	Type:
	Comments:

### Dimension and Mounting

#### **TECHOLED-MT-FM-10**

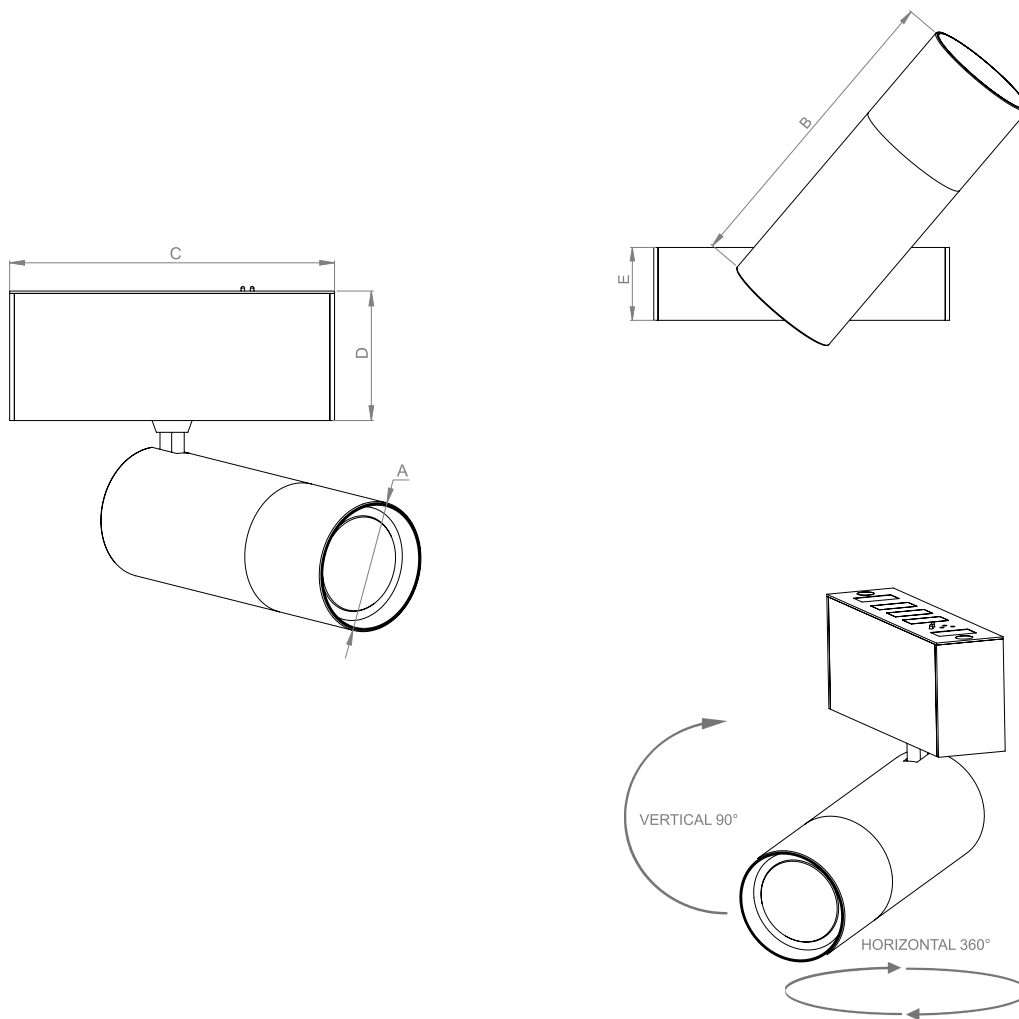

FIXTURE ID	A	B	C	D	E
TechoLED-MT-FM-10	2.2"	5.74"	5.43"	2.16"	1.34"

Project:	Type:
	Comments:

### Photometrics

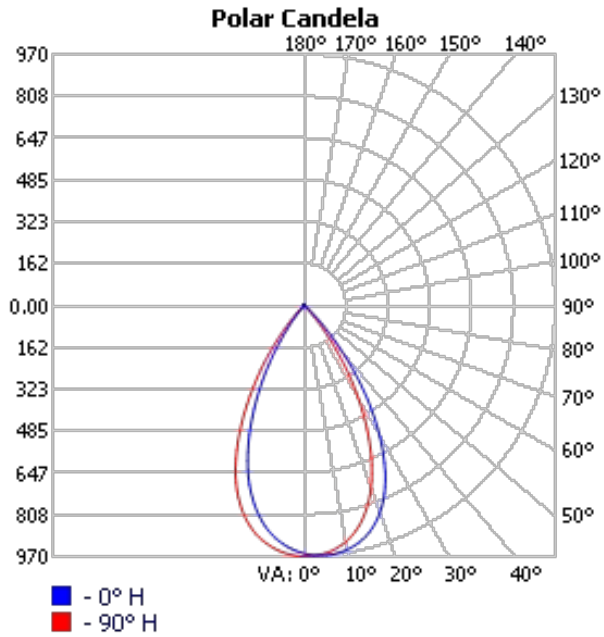

Project:	Type:
	Comments:

### Finish Details (powder coat finish)

#### ■ Standard Colors

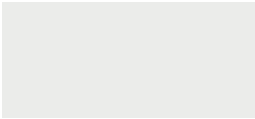

W – White



B – Black

#### ■ Custom Colors



RAL 1003



RAL 2004



RAL 3000



RAL 4001



RAL 5002



RAL 6000



RAL 6038



RAL 7001



RAL 1036



RAL 8029

Any RAL color available, please refer to [ralcolorchart.com](http://ralcolorchart.com)

#### ■ Custom Wooden Colors



American Walnut

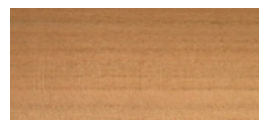

Cherry

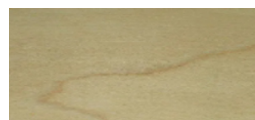

Maple



Light Oak



Palisander Santos

Project:	Type:
	Comments:

### Color Temperature

#### Color Temperature

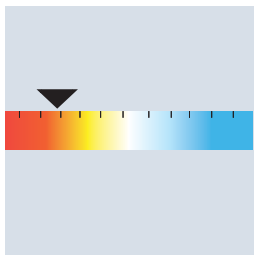

2700K

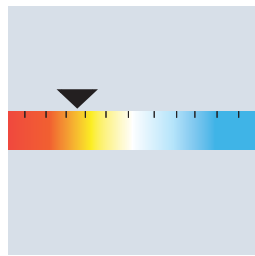

3000K

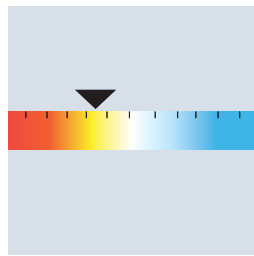

3500K

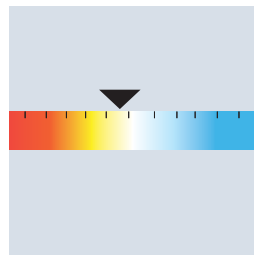

4000K

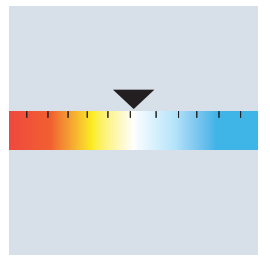

5000K

#### Tunable White

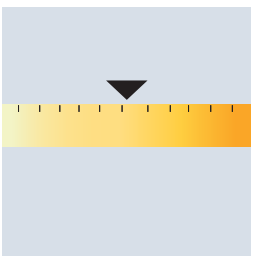

Dim To Warm

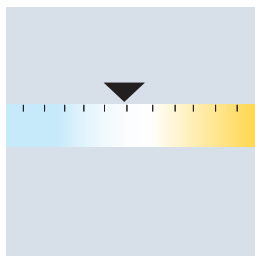

Tunable White