

Project:	Type:
	Comments:



Highlights

The TechoLED Moon series features smooth, round LED luminaires made with high-end aluminum extrusion and a PMMA diffuser. With diameters ranging from 11.8" to 47.2" (or a custom size of your choice), direct and direct/indirect illumination, and surface-mounted or pendant installation, it offers a simple yet sleek lighting solution for any modern interior.

LED: Samsung LED chips, 2700-5000K, tunable white and RGB/RGBW available, 90CRI, 50,000 hour rated lifespan. Custom lumen packages available.

Optical: Direct configuration, 115° Beam angle

Construction: Damp location listed. High grade aluminum extrusion, PMMA diffuser, integral driver (inside canopy in pendant version), powder coat finish, custom finishes available.

Installation

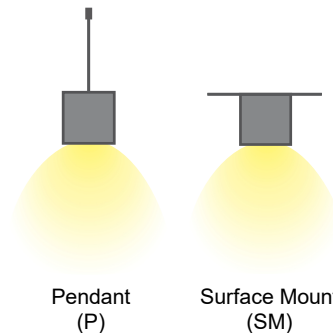

Project:	Type:
	Comments:

Configuration Example

Model #	Distribution	Diameter	Output	Color Temp.	Voltage	Finish
TECHOLED-MS-D-11-ME-30-U-S	Direct	11.8"	Medium	3000K	110-277V	Silver

Ordering Guide:

Select one option from each group below. For a custom preference please contact sales@techoled.com

1-FIXTURE ID		2-DISTRIBUTION		3-DIAMETER		4-WATTAGE	
MS	MS - Circle	D	Direct	11	11.8"	HI	High
				15	15.7"	LO	Low
				18	18.9"	ME	Medium
				23	23.6"		
				35	35.4"		
				47	47.2"		

5-COLOR TEMP.		6-VOLTAGE		7-FINISH		8-MOUNTING	
27	2700K	U	110-277V	S	Silver	P	Pendant
30	3000K	HV	347V	W	White	SM	Surface Mount
35	3500K			B	Black		
40	4000K			C	Custom (RAL#)		
50	5000K						
RGB	RGB						
RGBW	RGBW						
D	Tunable White						

9-DRIVER OPTIONS		10-OPTIONS		11-OPTIONS (CONT.)	
DM	0-10V Dimming	RF-D	Remote Tunable (RF only)	EM	EM Battery (remote)
2C	2 Channel	RF-R	Remote RGB/W (RF only)	X	None
DM1%	1% Dimming	M	Motion Sensor (remote)		
LT1	LDE1 Lutron 1%	BM	BubblyNet BT Mesh		
DA	Dali	CS	Casambi		
DMX	DMX	AWNR	Lutron Athena Node		
TR	Triac Dimming	AWNS	Lutron Athena Node sensor		
RF	RF Wireless	NL-ES7	nLight - Wired		
X	None	NL-AIR	nLight - AIR		
		NL-M	nLight - Module only		
		X	None		

Project:	Type:
	Comments:

Lumen Output Details

Model #	Diameter	Output	Color Temp.	Wattage	Lumen Output
TECHOLED-MS-D-11-LO-30-U-S	11.8"	Low	3000K	18W	1530Lm
TECHOLED-MS-D-11-ME-30-U-S	11.8"	Medium	3000K	18W	1530Lm
TECHOLED-MS-D-11-HI-30-U-S	11.8"	High	3000K	25W	2125Lm
TECHOLED-MS-D-15-LO-30-U-S	15.7"	Low	3000K	18W	1530Lm
TECHOLED-MS-D-15-ME-30-U-S	15.7"	Medium	3000K	20W	1700Lm
TECHOLED-MS-D-15-HI-30-U-S	15.7"	High	3000K	30W	2550Lm
TECHOLED-MS-D-18-LO-30-U-S	18.9"	Low	3000K	18W	1530Lm
TECHOLED-MS-D-18-ME-30-U-S	18.9"	Medium	3000K	25W	2125Lm
TECHOLED-MS-D-18-HI-30-U-S	18.9"	High	3000K	40W	3400Lm
TECHOLED-MS-D-23-LO-30-U-S	23.6"	Low	3000K	25W	2125Lm
TECHOLED-MS-D-23-ME-30-U-S	23.6"	Medium	3000K	40W	3400Lm
TECHOLED-MS-D-23-HI-30-U-S	23.6"	High	3000K	60W	5100Lm
TECHOLED-MS-D-35-LO-30-U-S	35.4"	Low	3000K	50W	4250Lm
TECHOLED-MS-D-35-ME-30-U-S	35.4"	Medium	3000K	90W	7650Lm
TECHOLED-MS-D-35-HI-30-U-S	35.4"	High	3000K	135W	11475Lm
TECHOLED-MS-D-47-LO-30-U-S	47.2"	Low	3000K	80W	6800Lm
TECHOLED-MS-D-47-ME-30-U-S	47.2"	Medium	3000K	150W	12750Lm
TECHOLED-MS-D-47-HI-30-U-S	47.2"	High	3000K	200W	17000Lm

Performance above applies to 90 CRI, 3000K. Calculate 96% for 2700K, 104% for 3500K and 109% for 4000K

Performance

Output	Lumens / W
Low	85
Medium	85
High	85

Project:	Type:
	Comments:

Driver Option Details

Code	Description
LT1	LDE1 - Lutron Hi-lume 1% EcoSystem, Soft-on, Fade-to Black Dimming
DA	DALI
DMX	DMX - Decoder provided by TechoLED, controller by others

Controls Details

Code	Description
RF-D	RF Wireless remote controller for tunable white. Default for tunable white.
RF-R	RF Wireless remote controller for RGB & RGBW. Default for RGB & RGBW.
M	Motion Sensor - remote, for integral sensor consult factory
BM	Bluetooth Mesh Smart Wireless Control by BubblyNet
CS	Bluetooth Mesh Smart Wireless Control by Casambi
AWN R	Lutron Athena wireless node
AWN S	Lutron Athena wireless node with sensor
NL-ES7	Acuity nLight - Wired nES7 sensor
NL-AIR	Acuity nLight - AIR wireless rES7 sensor
NL-M	Acuity nLight - ready, sensor by others

Options (cont.) Details

Code	Description
EM	Emergency Battery Backup (remote)

Project:	Type:
	Comments:

Dimensions and Mounting (Surface Mount)

TECHOLED-MS-D-11-15

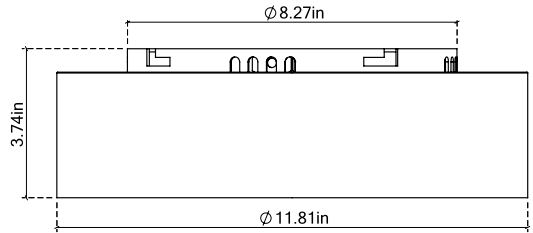
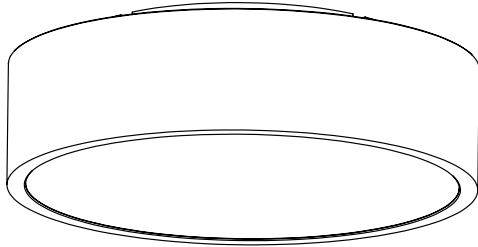

TECHOLED-MS-D-15-20

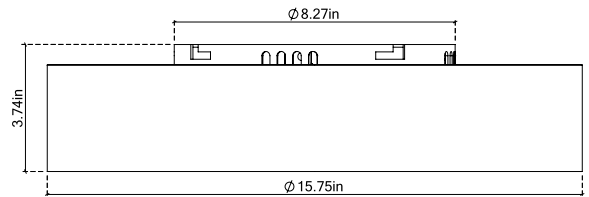
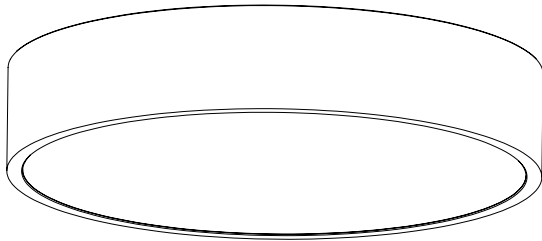

TECHOLED-MS-D-18-25

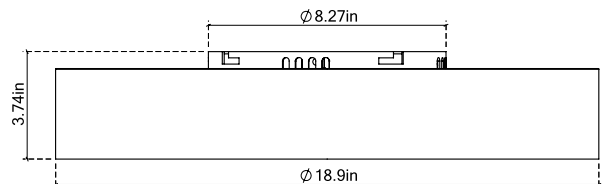
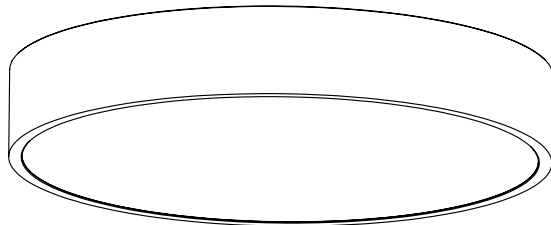

Project:	Type:
	Comments:

■ **TECHOLED-MS-D-23-40**

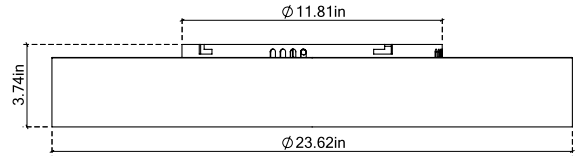
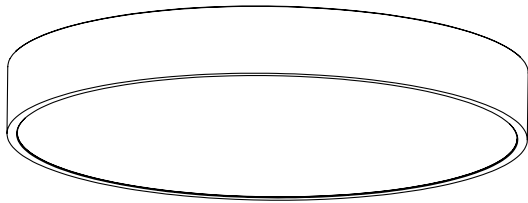

■ **TECHOLED-MS-D-35-90**

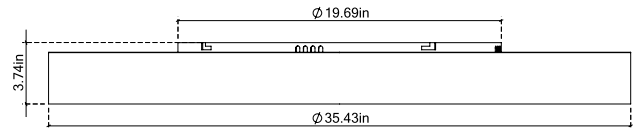
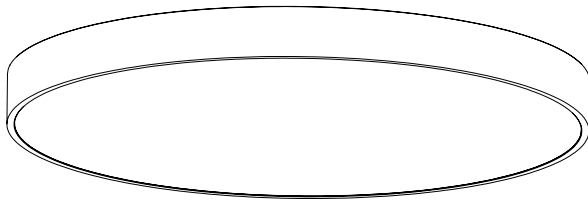

■ **TECHOLED-MS-D-47-150**

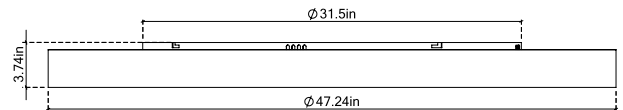
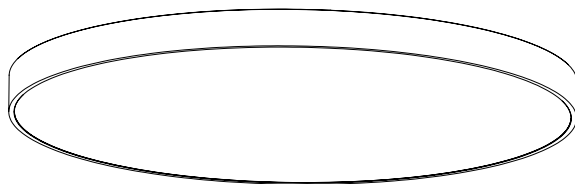

Project:	Type:
	Comments:

□ Dimensions and Mounting (Pendant)

■ TECHOLED-MS-D-11-15

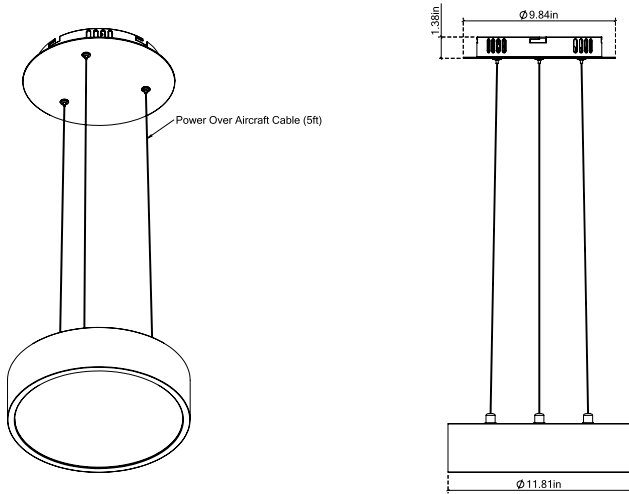

■ TECHOLED-MS-D-15-20

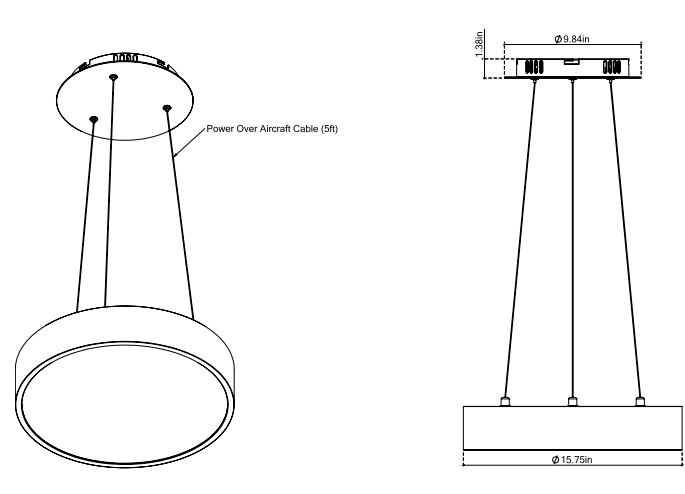

■ TECHOLED-MS-D-18-25

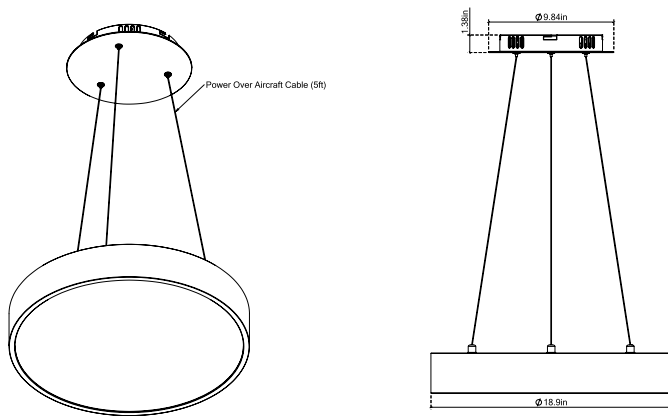

■ TECHOLED-MS-D-23-40

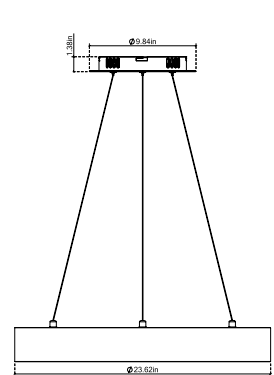

Project:	Type:
	Comments:

■ **TECHOLED-MS-D-35-90**

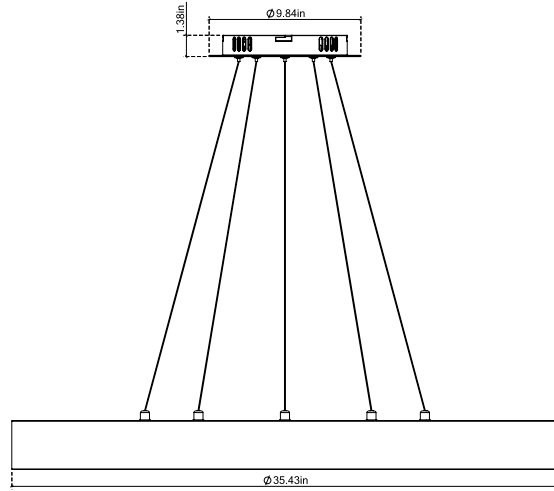
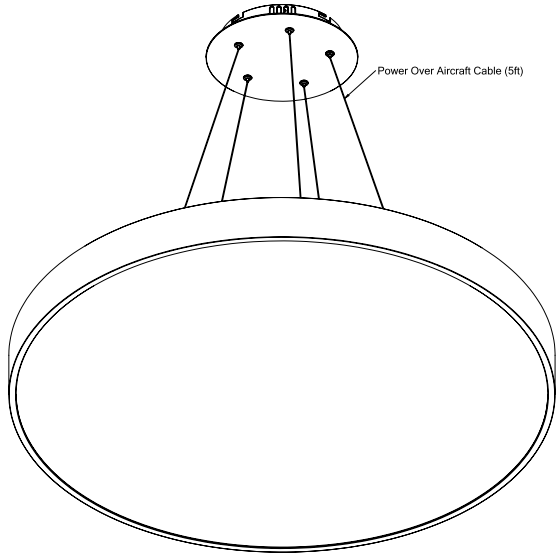

■ **TECHOLED-MS-D-47-150**

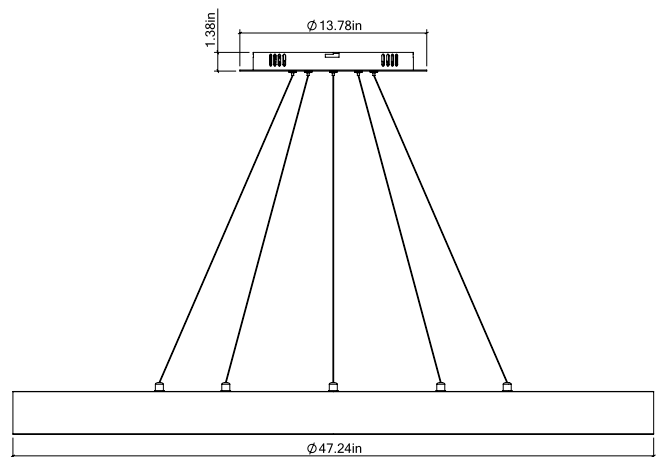
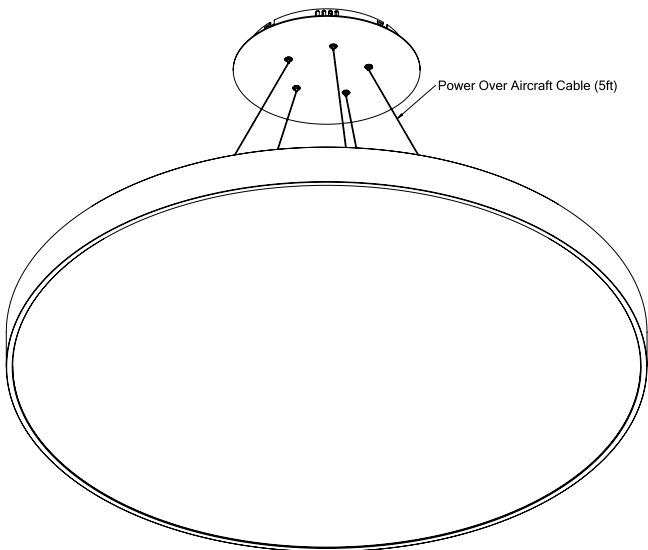

Project:	Type:
	Comments:

Photometrics

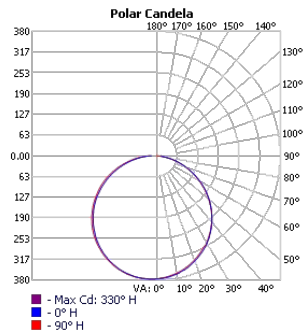

TECHOLED-MS-D-11-ME-30

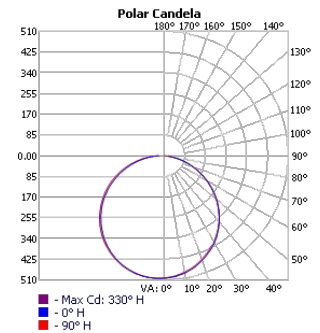

TECHOLED-MS-D-11-HI-30

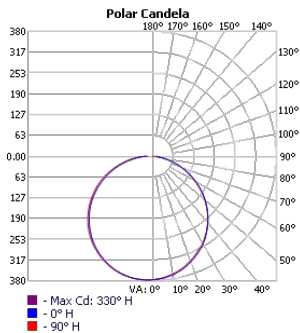

TECHOLED-MS-D-15-LO-30

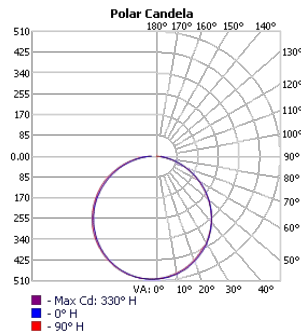

TECHOLED-MS-D-15-ME-30

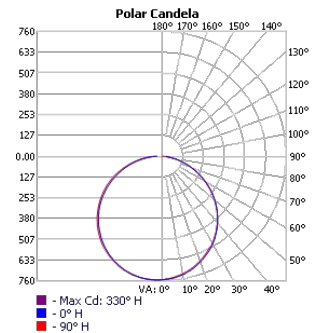

TECHOLED-MS-D-15-HI-30

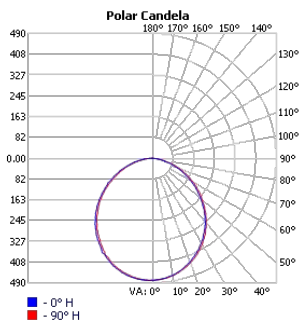

TECHOLED-MS-D-18-LO-30

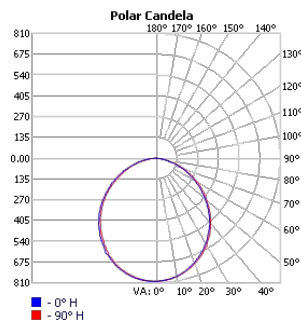

TECHOLED-MS-D-18-ME-30

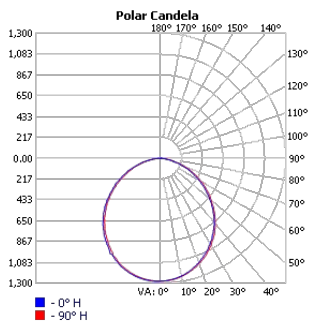

TECHOLED-MS-D-18-HI-30

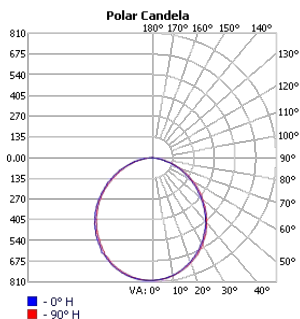

TECHOLED-MS-D-23-LO-30

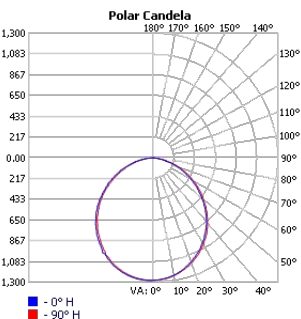

TECHOLED-MS-D-23-ME-30

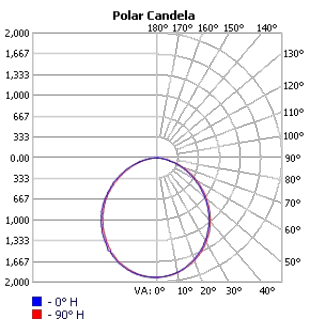

TECHOLED-MS-D-23-HI-30

Project:	Type:
	Comments:

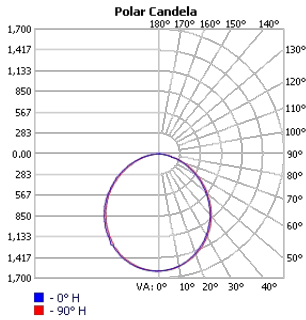

TECHOLED-MS-D-35-LO-30

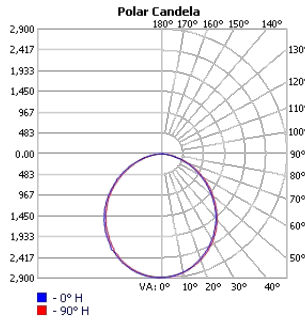

TECHOLED-MS-D-35-ME-30

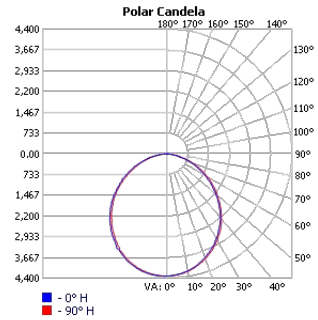

TECHOLED-MS-D-35-HI-30

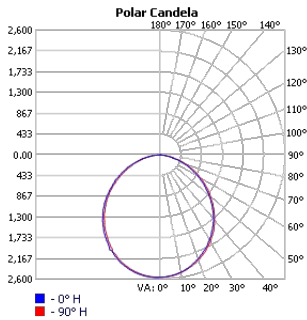

TECHOLED-MS-D-47-LO-30

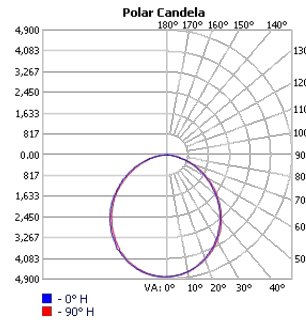

TECHOLED-MS-D-47-ME-30

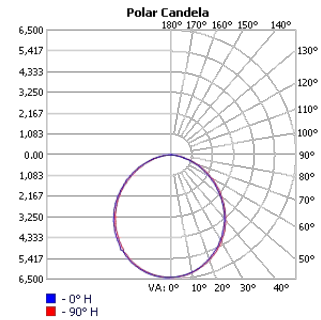

TECHOLED-MS-D-47-HI-30

Project:	Type:
	Comments:

Finish Details (powder coat finish)

■ Standard Colors



■ Custom Colors

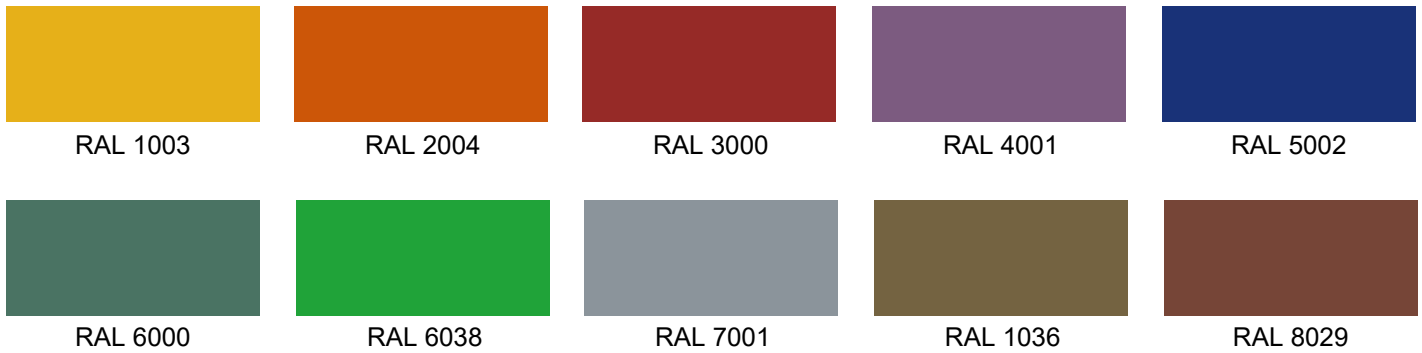

Any RAL color available, please refer to ralcolorchart.com

■ Custom Wooden Colors

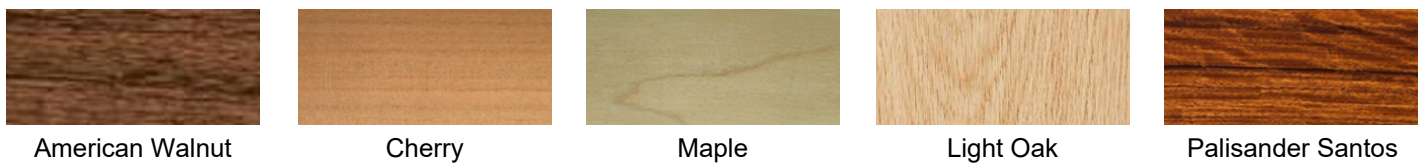

Project:	Type:
	Comments:

Color Temperature

Color Temperature

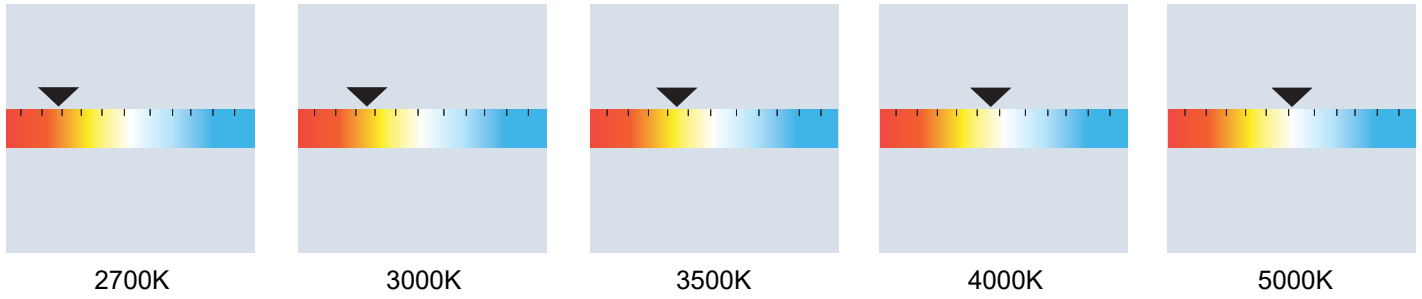

Tunable White

