

Project:	Type:
	Comments:



Highlights

The TechoLED X Line Series is a specification grade, track lighting system. Track heads ranging from simple, high output models, to projectors with museum grade optics and light quality. Wide range of accessories and adapters for compatibility with all major tracks. Versatile and sophisticated lighting solution for all modern commercial and residential applications.

LED: Cree LED Chips, 2700-5000K, 95+ CRI

Optical: Direct illumination, 15°-60° beam angles available

Construction: 120V input voltage. High-grade die cast aluminum, powder coat finish, custom finishes available

Cross Section

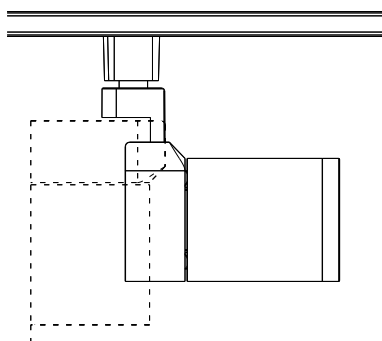

Installation

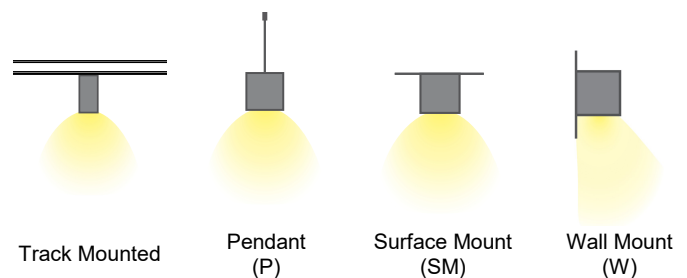

Project:	Type:
	Comments:

Configuration Example

Model #	Lumen Output	Beam Angle	Color Temp.	Finish	Mounting	Accessories
TECHOLED-XC-ME-36-30-B-H-HL	Medium	36°	3000K	Black	Halo	Honeycomb louvre

Ordering Guide:

Select one option from each group below. For a custom preference please contact sales@techoled.com

1-FIXTURE ID		2-LUMEN OUTPUT		3-BEAM ANGLE		4-COLOR TEMPERATURE	
XC	X - CORE	LO	Low	15	15°	27	2700K
		ME	Medium	24	24°	30	3000K
		HI	High	36	36°	35	3500K
				60	60°	40	4000K
						50	5000K

5-FINISH		6-MOUNTING		7-ACCESSORIES		8-OPTIONS	
B	Black	H	Halo *	HL	Honeycomb Louvre	DA	Dali
W	White	J	Juno *	CL	Cross Louvre	X	None
C	Custom (RAL#)	L	Lightolier *	S	Snoot		
		T	TEK *	YS	Eye Snoot		
		HT	HTEK *	WW	Wall Wash Ring		
		G	Global *	BD	'Barn Door' Shades		
		W	Wall Mount				
		P	Pendant				
		SM	Surface Mount				

Project:	Type:
	Comments:

Fixture ID Details

Code	Description
XC	X Series - Core

Lumen Output Details

Model #	Beam Angle	Output	Color Temp.	Wattage	Lumen Output
TECHOLED-XC-LO-15-30-B-H-HL	15°	Low	3000K	10W	964Lm
TECHOLED-XC-ME-15-30-B-H-HL	15°	Medium	3000K	20W	1349Lm
TECHOLED-XC-HI-15-30-B-H-HL	15°	High	3000K	30W	2590Lm

Performance above applies to 90CRI, 3000K. Calculate 96% for 2700K, 104% for 3500K and 109% for 4000K.

Performance

Output	LPW
Low	88
Medium	68
High	86

Mounting Details

Code	Description
H	Halo (single circuit)
J	Juno (single circuit)
L	Lightolier (single circuit)
T	TEK (2circuit)
HT	HTEK (2 circuit)
G	G - Global (3 circuit)

Project:	Type:
	Comments:

Dimension and Mounting

■ **10W Model**

■ **20-30W Model**

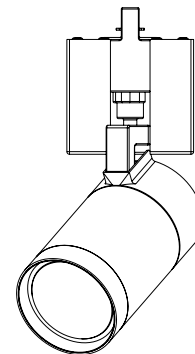
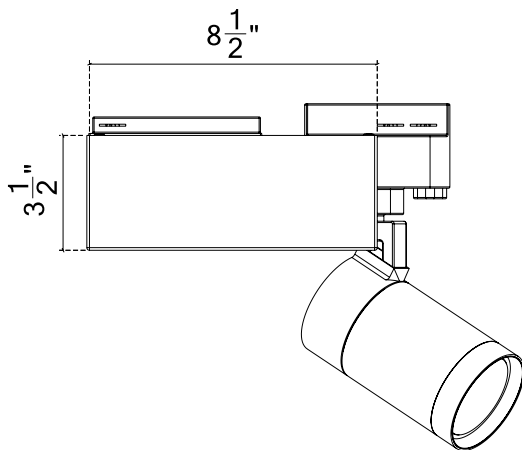
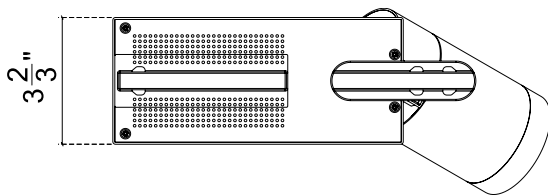
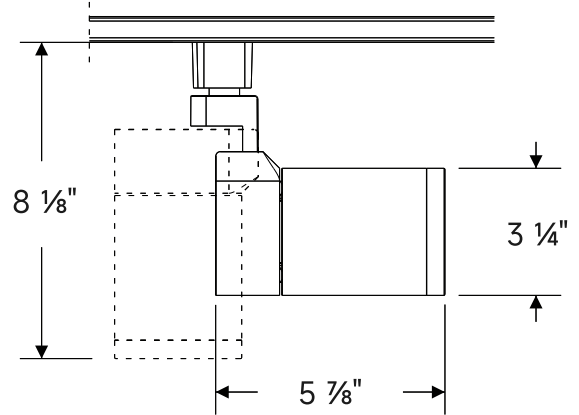
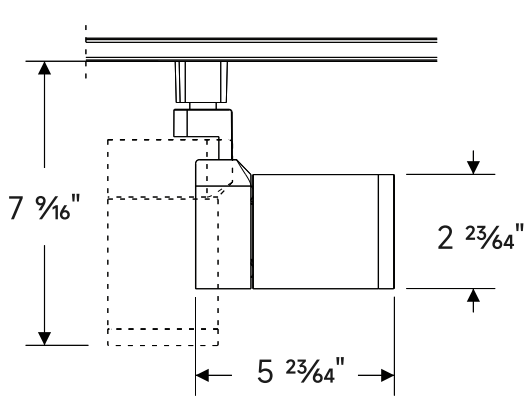

Project:	Type:
	Comments:

Modular System Overview

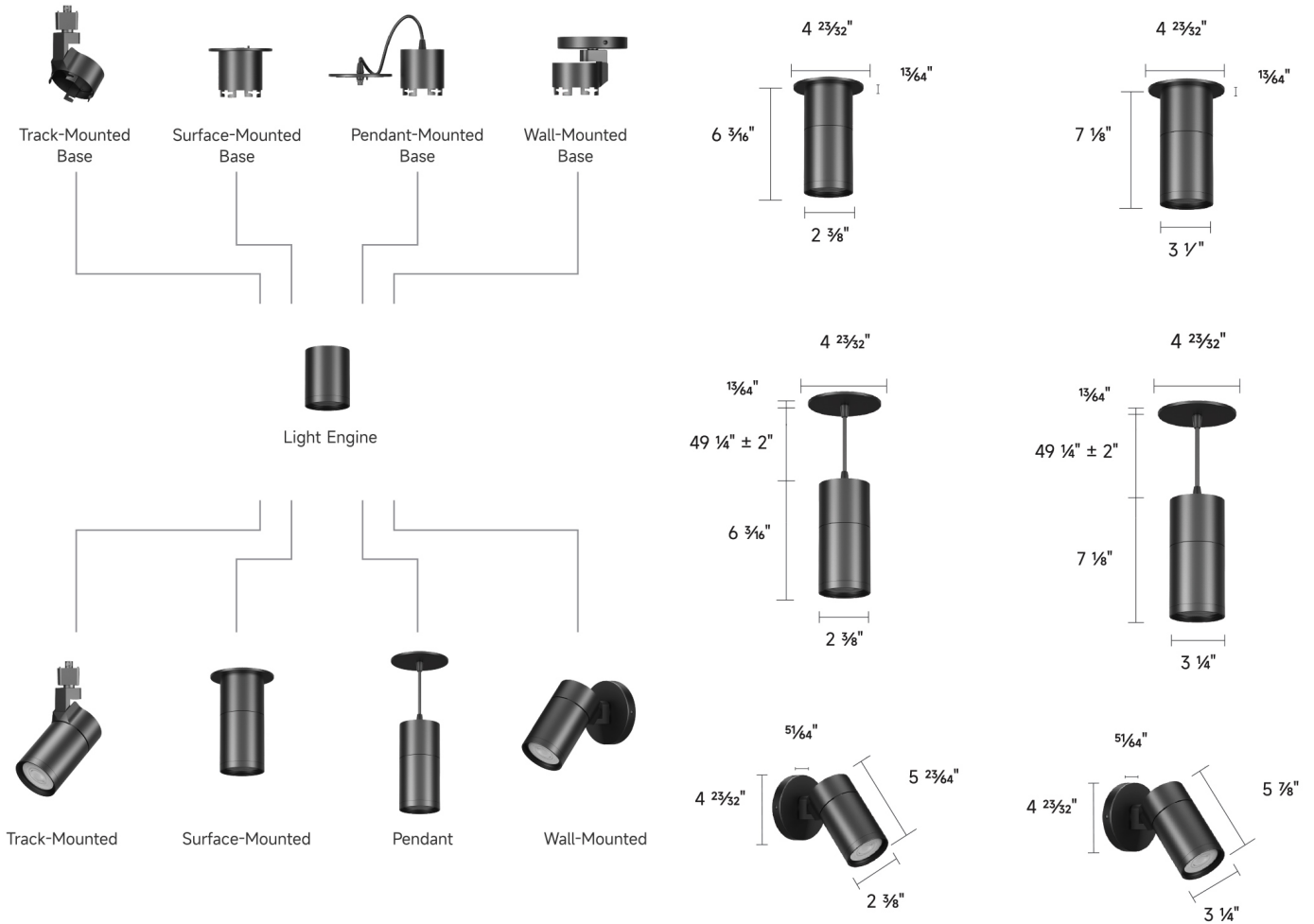

Project:	Type:
	Comments:

Accessories

■ **Honeycomb louvre**



■ **Cross louvre**



■ **Snoot**



■ **Eye snoot**



■ **Wall wash ring**



■ **'Barn door' shades**



Project:	Type:
	Comments:

Photometrics

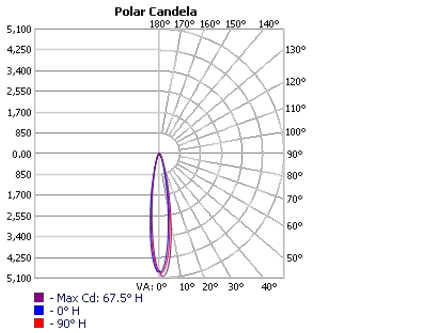

TECHOLED-XC-LO-15-30-B-H-HL

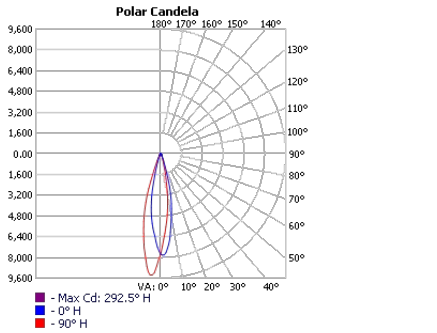

TECHOLED-XC-ME-15-30-B-H-HL

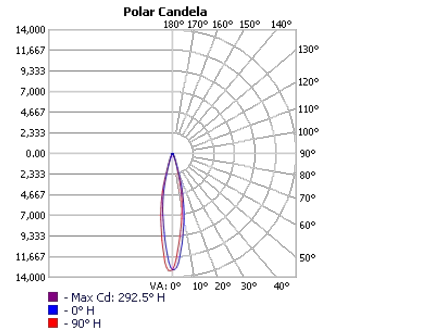

TECHOLED-XC-HI-15-30-B-H-HL

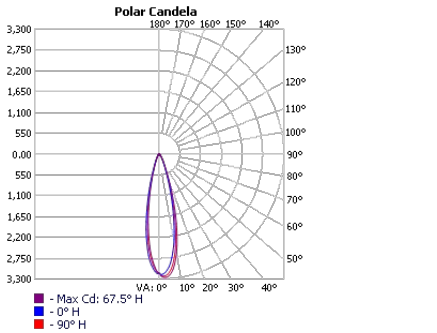

TECHOLED-XC-LO-24-30-B-H-HL

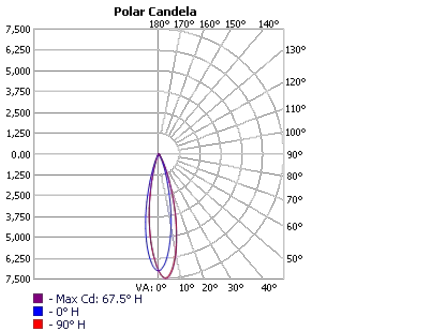

TECHOLED-XC-ME-24-30-B-H-HL

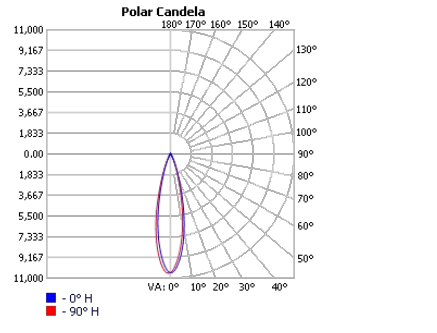

TECHOLED-XC-HI-24-30-B-H-HL

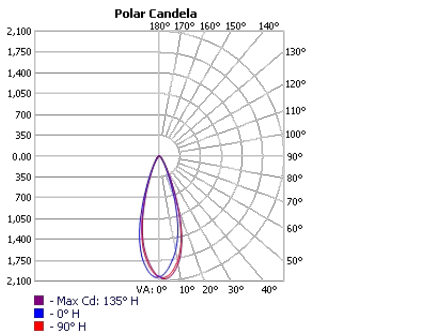

TECHOLED-XC-LO-36-30-B-H-HL

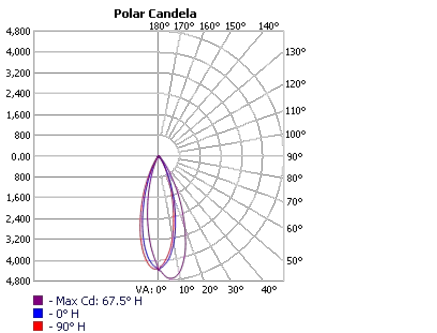

TECHOLED-XC-ME-36-30-B-H-HL

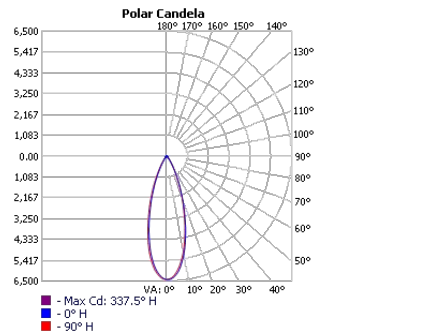

TECHOLED-XC-HI-36-30-B-H-HL

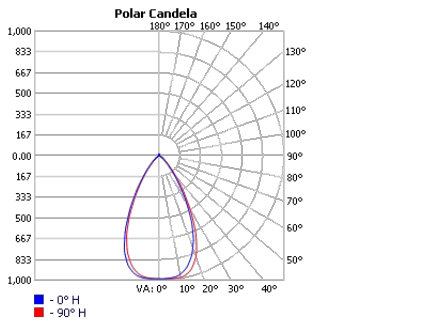

TECHOLED-XC-LO-60-30-B-H-HL

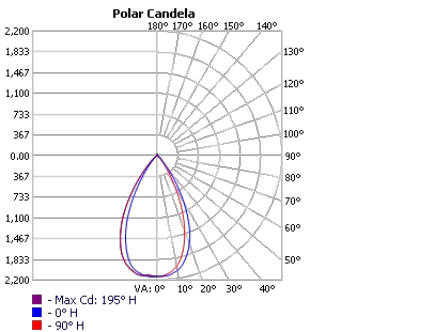

TECHOLED-XC-ME-60-30-B-H-HL

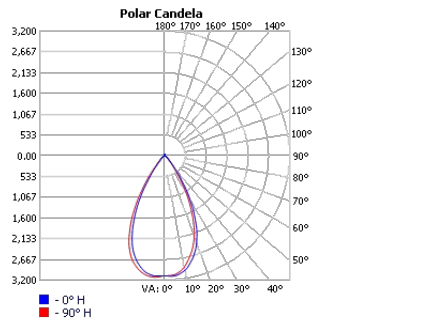

TECHOLED-XC-HI-60-30-B-H-HL

Project:	Type:
	Comments:

Finish Details (powder coat finish)

■ Standard Colors

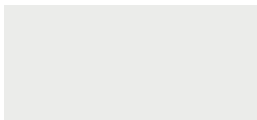

W – White



S – Silver



B – Black

■ Custom Colors



RAL 1003



RAL 2004



RAL 3000



RAL 4001



RAL 5002



RAL 6000



RAL 6038



RAL 7001



RAL 1036



RAL 8029

Any RAL color available, please refer to ralcolorchart.com

■ Custom Wooden Colors



American Walnut



Cherry

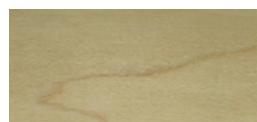

Maple



Light Oak



Palisander Santos

Project:	Type:
	Comments:

 **Color Temperature**

 **Color Temperature**

