

Project:	Type:
	Comments:



Highlights

The TechoLED X Line Series is a specification grade, track lighting system. Track heads ranging from simple, high output models, to projectors with museum grade optics and light quality. Wide range of accessories and adapters for compatibility with all major tracks. Versatile and sophisticated lighting solution for all modern commercial and residential applications.

LED: Cree LED Chips, 2700-5000K (field adjustable), 95+ CRI

Optical: Direct illumination, 25°-60° beam angle, field adjustable

Construction: 120V input voltage. High-grade die cast aluminum, powder coat finish, custom finishes available, digital display to adjust output and color temperature

Cross Section

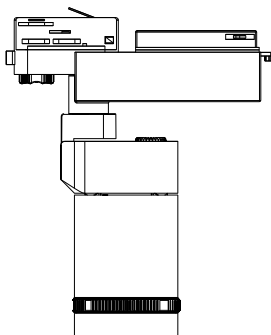

Installation

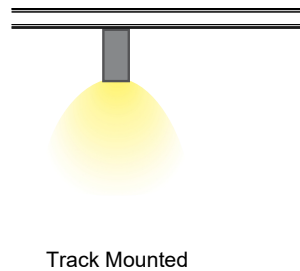

Project:	Type:
	Comments:

Configuration Example

Model #	Lumen Output	Beam Angle	Color Temp.	Finish	Mounting	Accessories
TECHOLED-XD-F-ADJ-D-B-H-HL	Field Adjustable	Adjustable	Dynamic	Black	Halo	Honeycomb Louvre

Ordering Guide:

Select one option from each group below. For a custom preference please contact sales@techoled.com

1-FIXTURE ID		2-LUMEN OUTPUT		3-BEAM ANGLE		4-COLOR TEMPERATURE	
XD	X - DYNAMIC	F	Field Adjustable	ADJ	Adjustable (25°-60°)	D	Dynamic *

5-FINISH		6-MOUNTING		7-ACCESSORIES	
B	Black	H	Halo *	HL	Honeycomb Louvre
W	White	J	Juno *	CL	Cross Louvre
C	Custom (RAL#)	L	Lightolier *	S	Snoot
		T	TEK *	YS	Eye Snoot
		HT	HTEK *	WW	Wall Wash Ring
		G	Global *	BD	'Barn Door' Shades

Project:	Type:
	Comments:

Fixture ID Details

Code	Description
XD	X Series - Dynamic

Lumen Output Details

Model #	Beam Angle	Output	Color Temp.	Wattage	Lumen Output
TECHOLED-XD-F-ADJ-D	25° - 60°	Adjustable	3000K	0-25W	0-1898Lm

Performance above applies to 90CRI, 3000K. Calculate 96% for 2700K, 104% for 3500K and 109% for 4000K.

Performance

Output	LPW
F	60

Mounting Details

Code	Description
H	Halo (single circuit)
J	Juno (single circuit)
L	Lightolier (single circuit)
T	TEK (2circuit)
HT	HTEK (2 circuit)
G	G - Global (3 circuit)

Color Temperature Details

Code	Description
D	Dynamic - 2700-6500K field adjustable

Beam Angle Details

Code	Description
ADJ	25° - 60° field adjustable

Project:	Type:
	Comments:

Modular System Overview

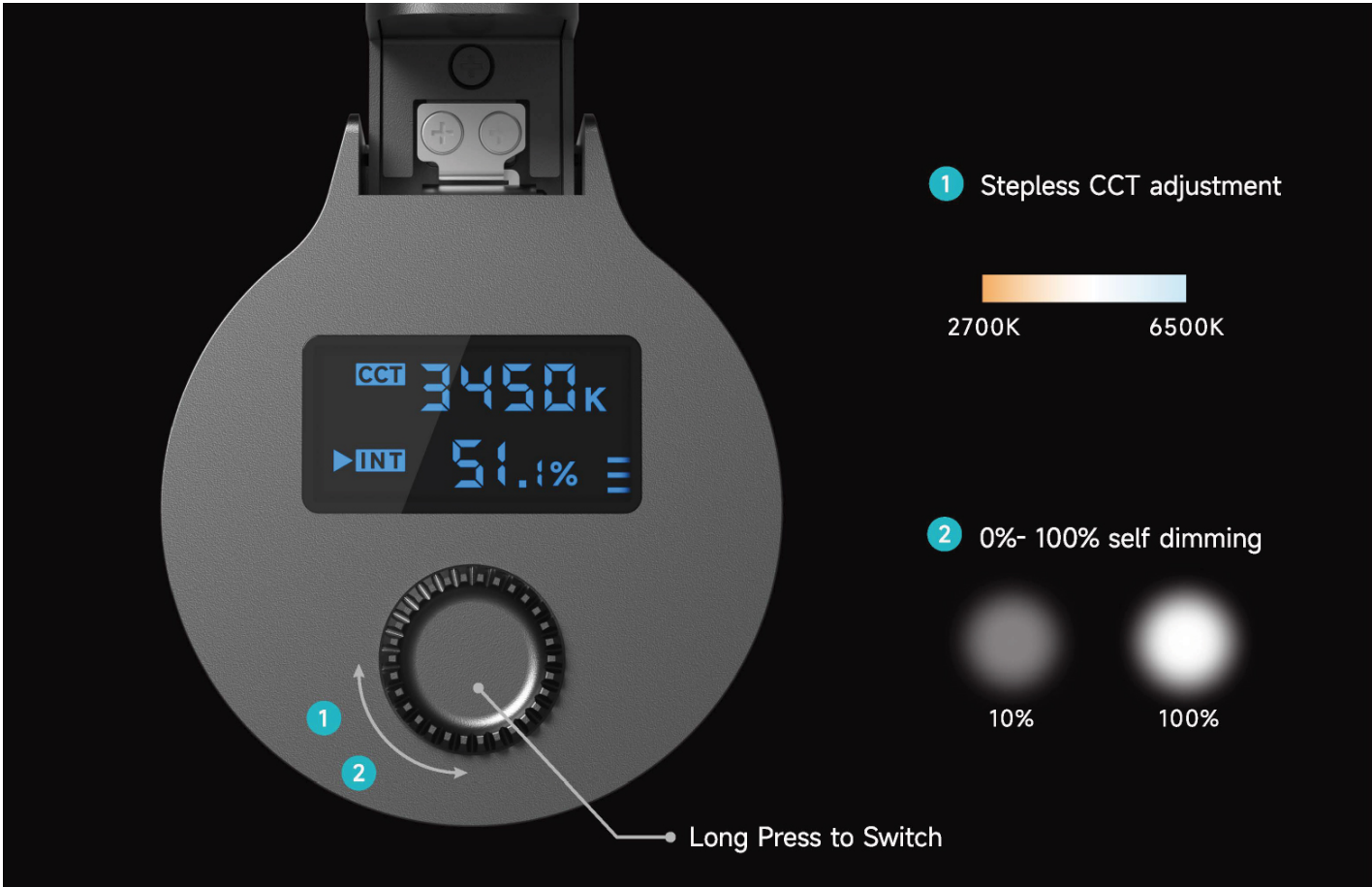

Project:	Type:
	Comments:

Dimension and Mounting

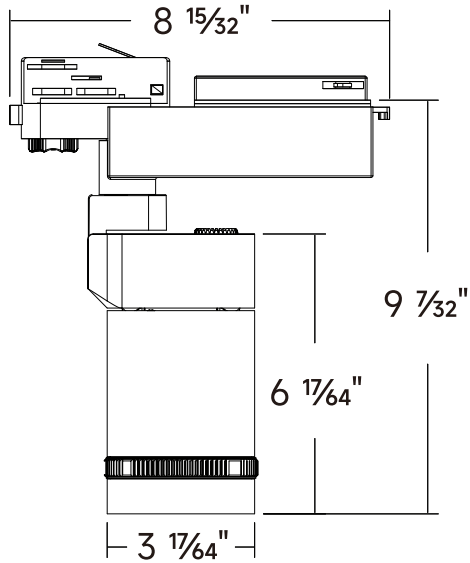

Accessories

■ Honeycomb louvre



■ Cross louvre



■ Snoot



■ Eye snoot



■ Wall wash ring



■ 'Barn door' shades



Project:	Type:
	Comments:

Photometrics

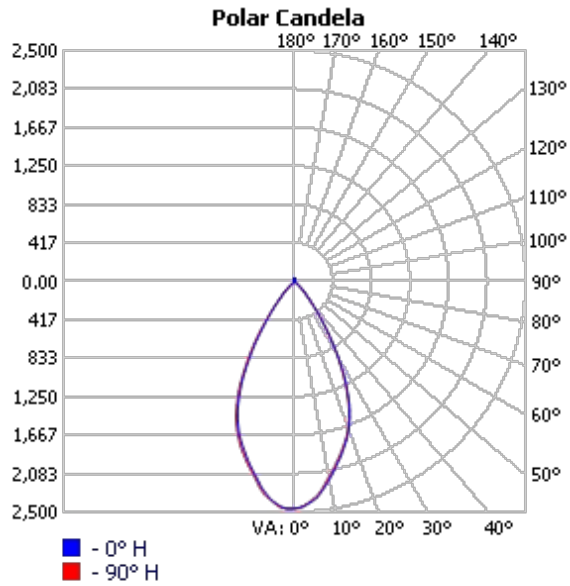

Project:	Type:
	Comments:

Finish Details (powder coat finish)

■ Standard Colors



■ Custom Colors

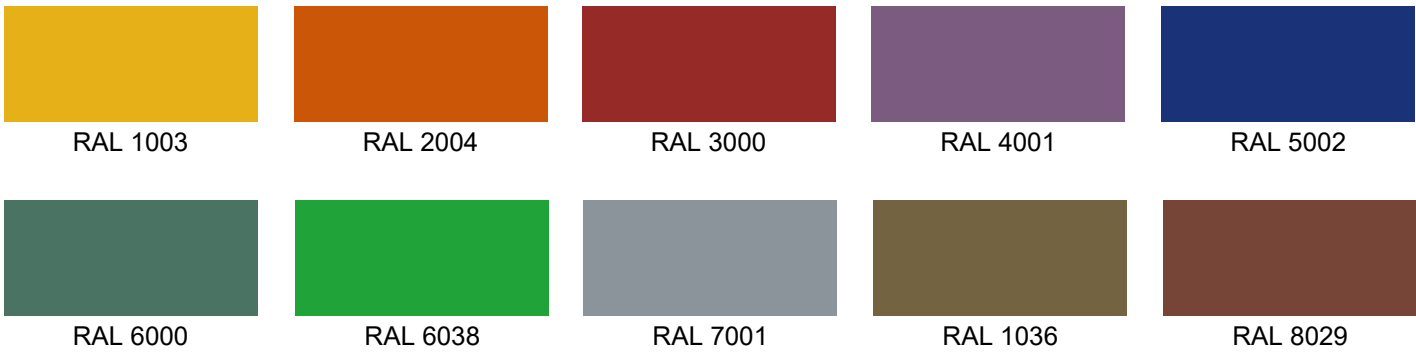

Any RAL color available, please refer to ralcolorchart.com

■ Custom Wooden Colors

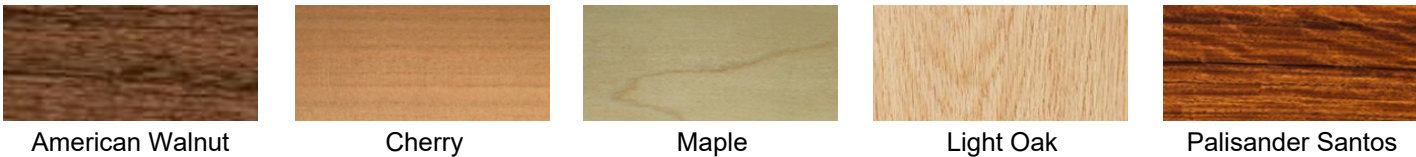

Project:	Type:
	Comments:

 **Color Temperature**

 **Color Temperature**

